

**TECHNIQUES
D'ACTIONS
IMMEDIATES**

LE TUBE
ARRIERE

SORTIE

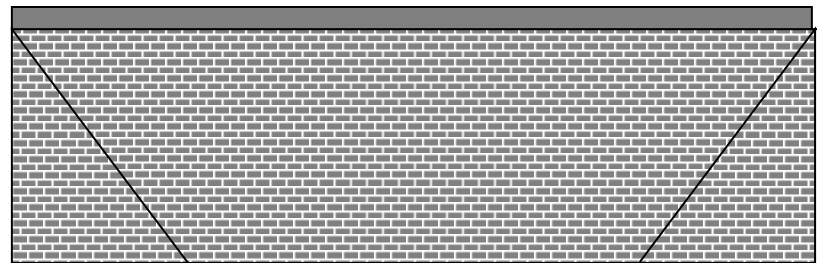
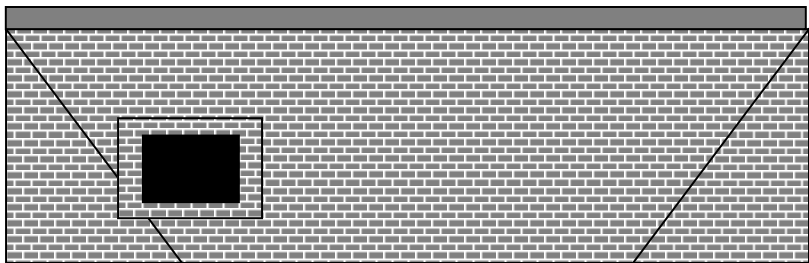
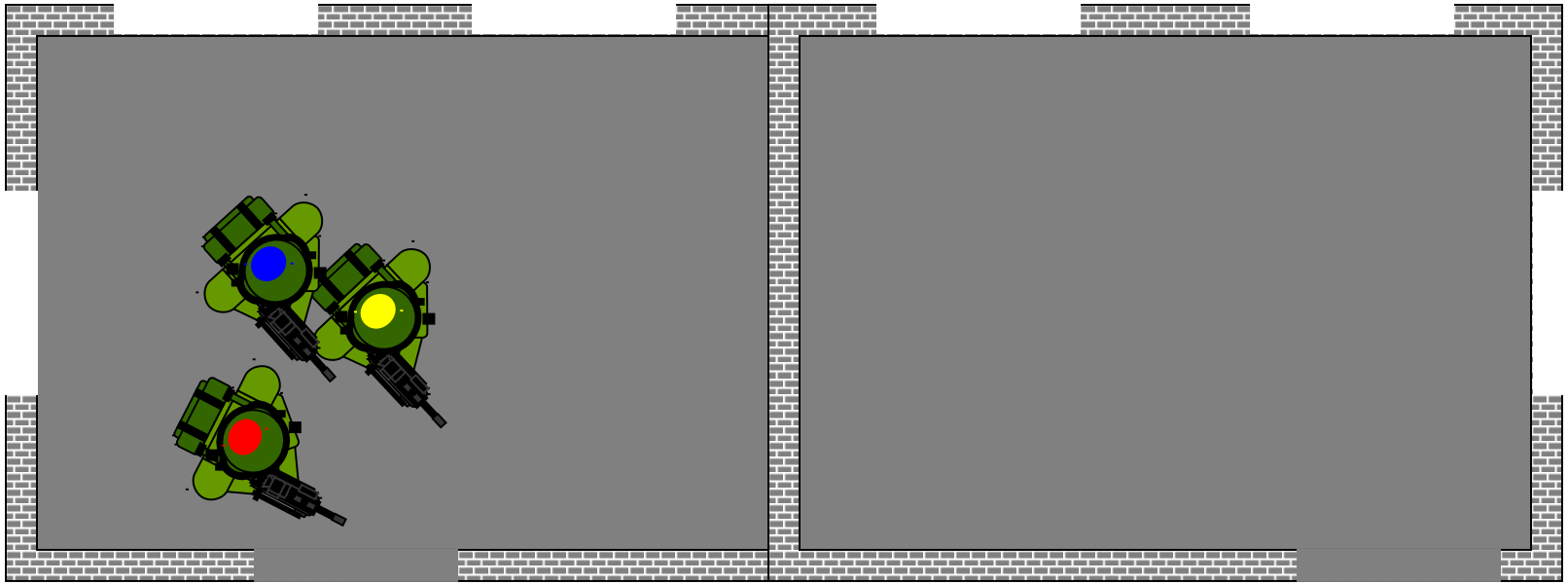

SORTIE

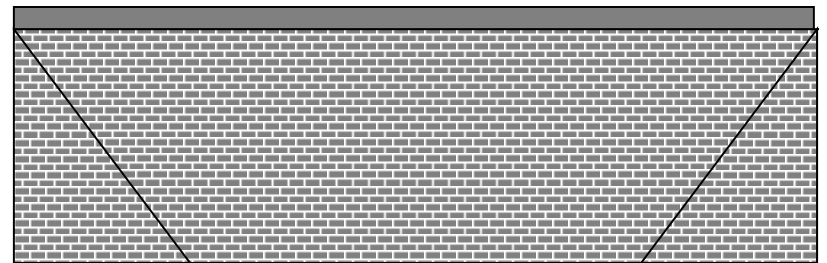
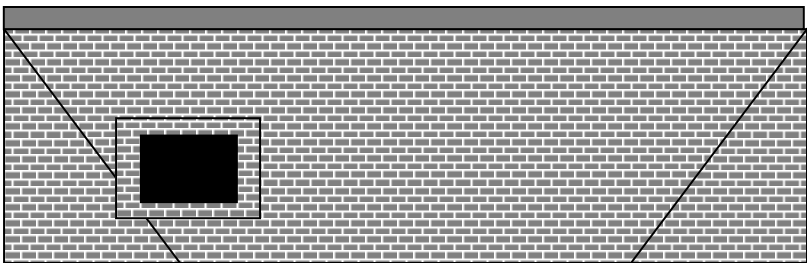
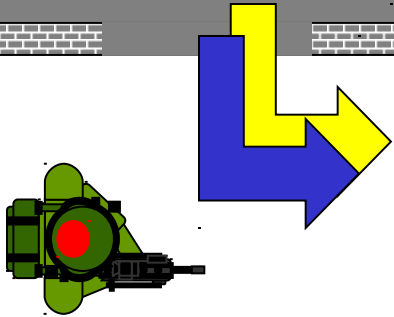
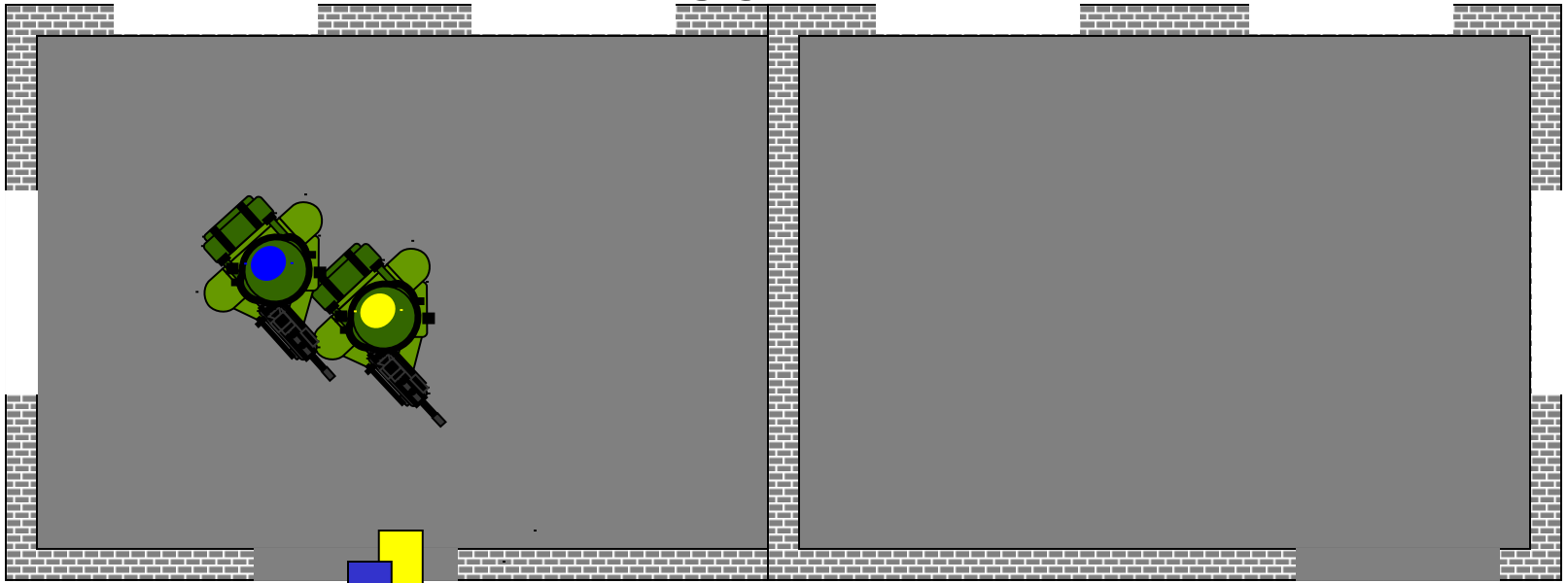

PROGRESSION

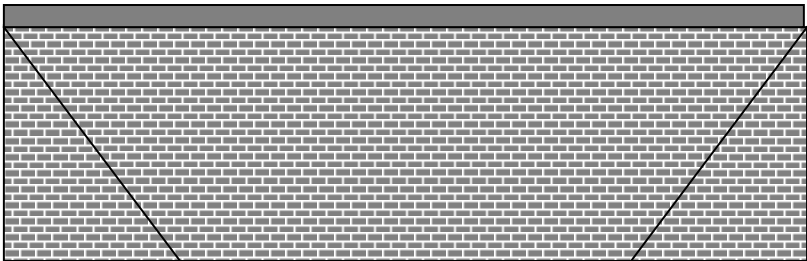
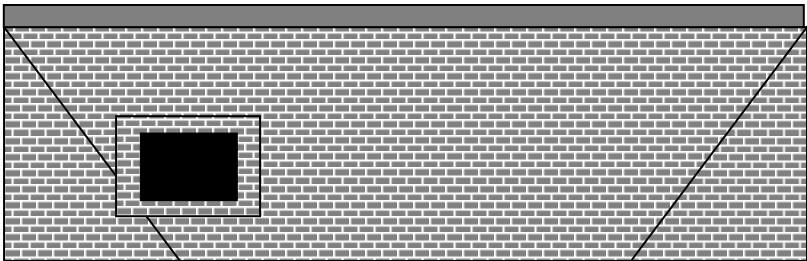
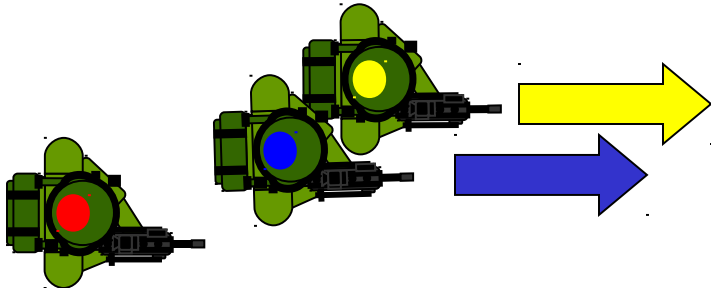
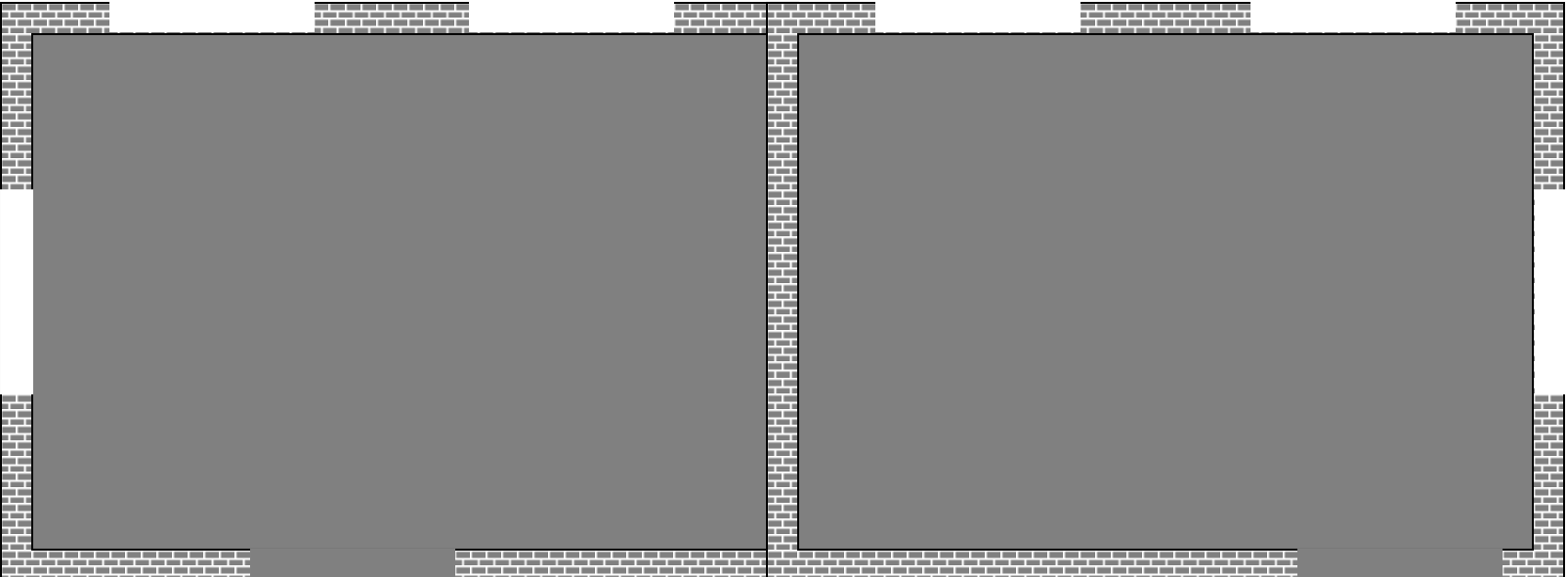

PROGRESSION

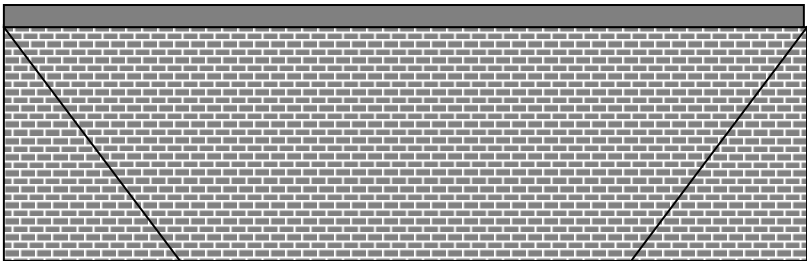
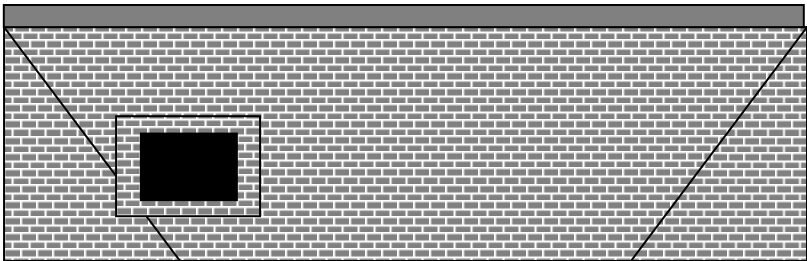
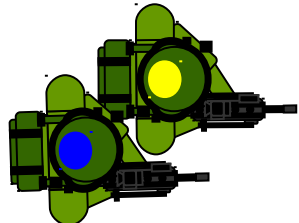
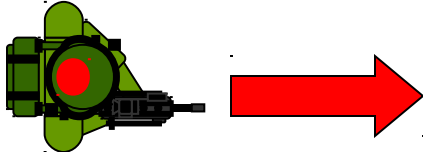
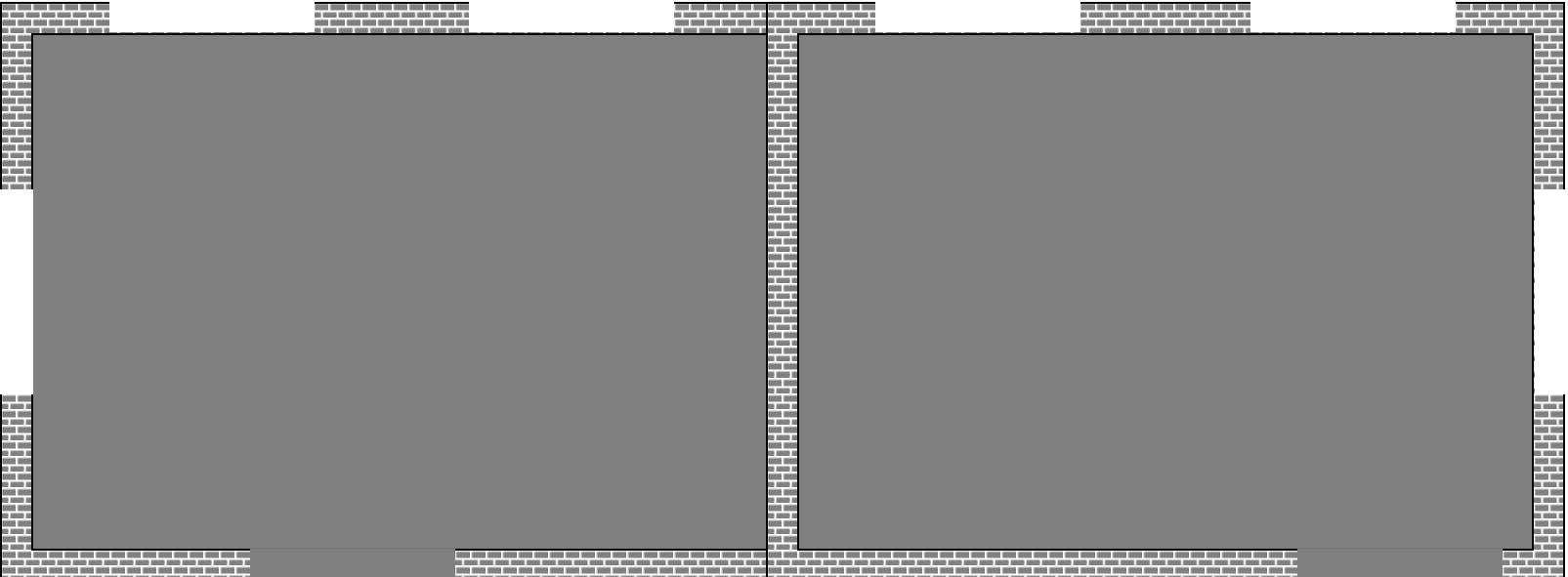

PRISE A PARTIE / ANNONCE / OUVERTURE DU FEU

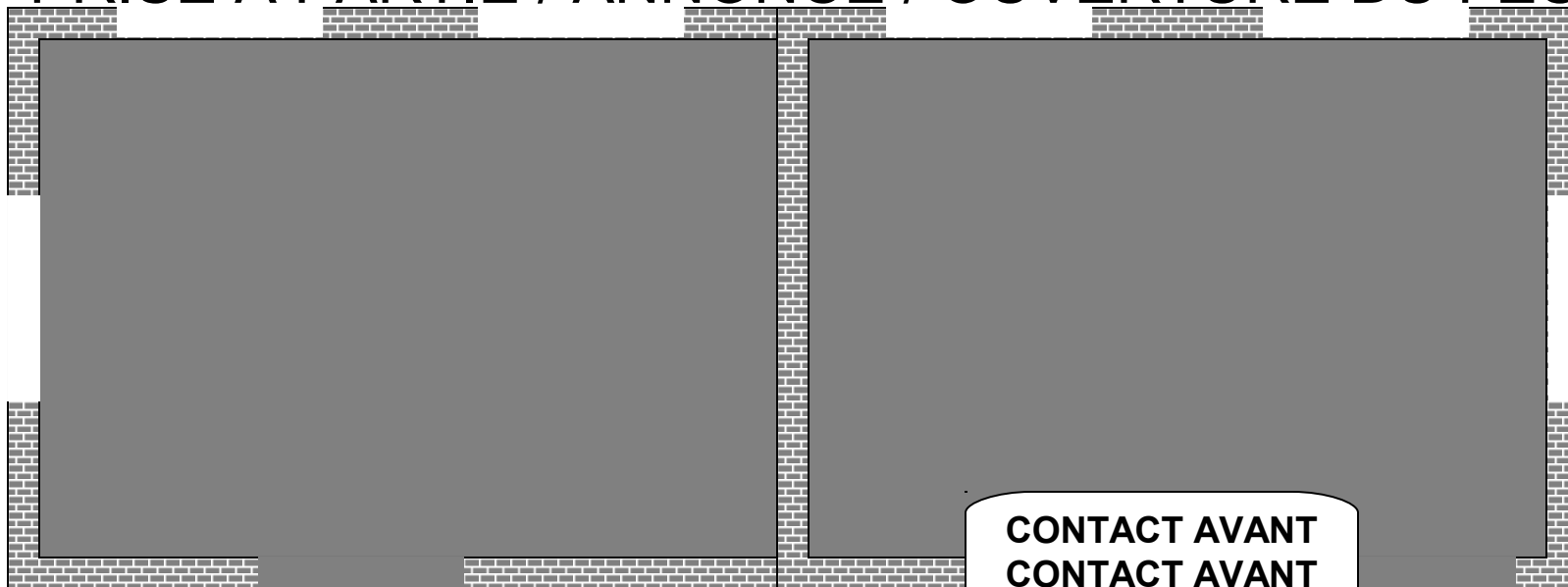

CONTACT AVANT
CONTACT AVANT

CONTACT AVANT
CONTACT AVANT

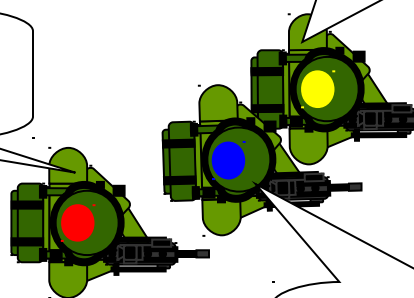

PAN.....PAN



CONTACT AVANT
CONTACT AVANT

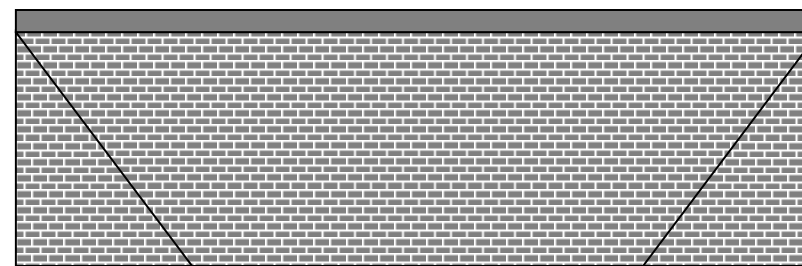
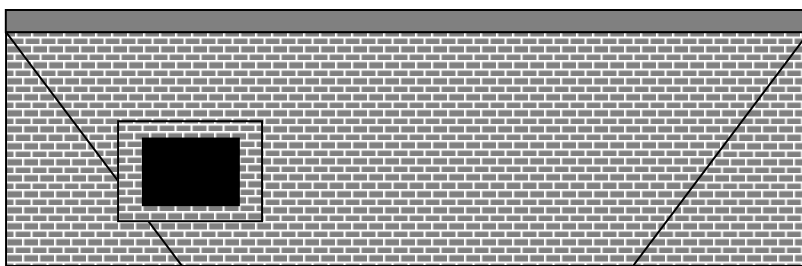

PRISE DE DECISION / REPERCUTION

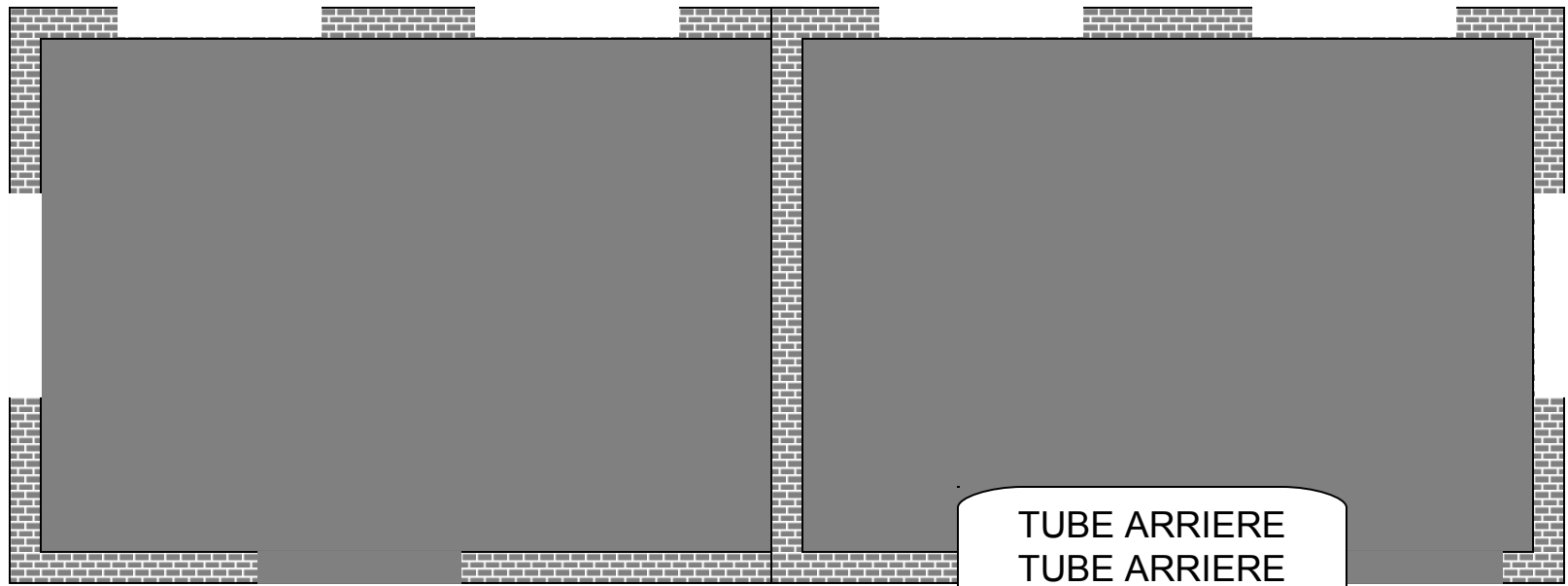

TUBE ARRIERE
TUBE ARRIERE

TUBE ARRIERE
TUBE ARRIERE

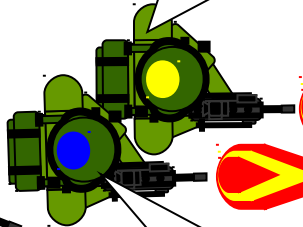
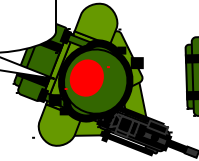

PAN.....PAN

PAN.....PAN

TUBE ARRIERE
TUBE ARRIERE

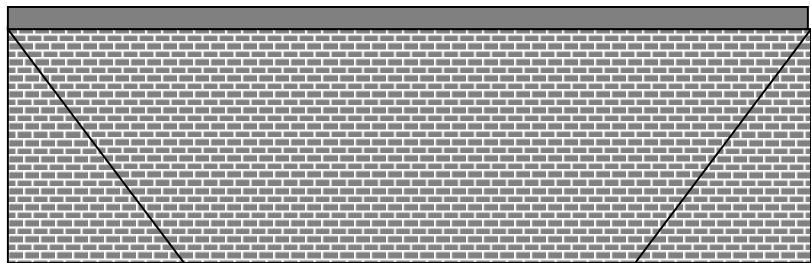
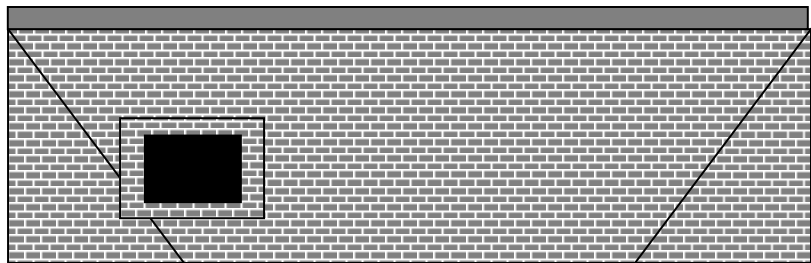

EXECUTION

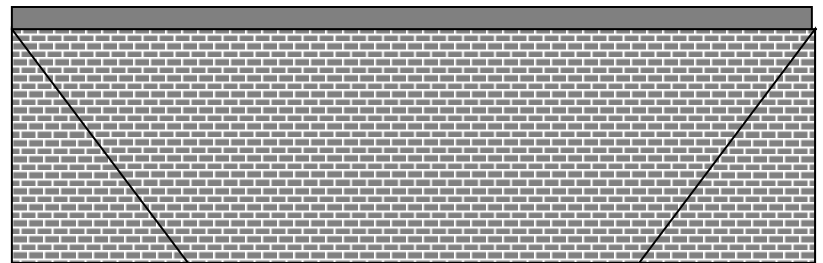
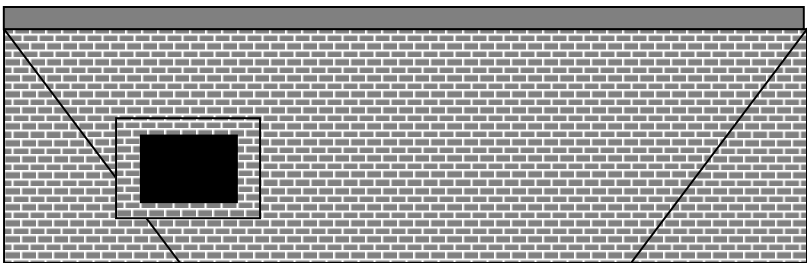
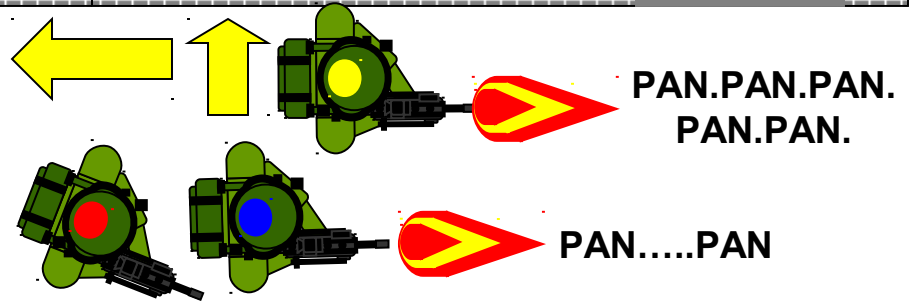
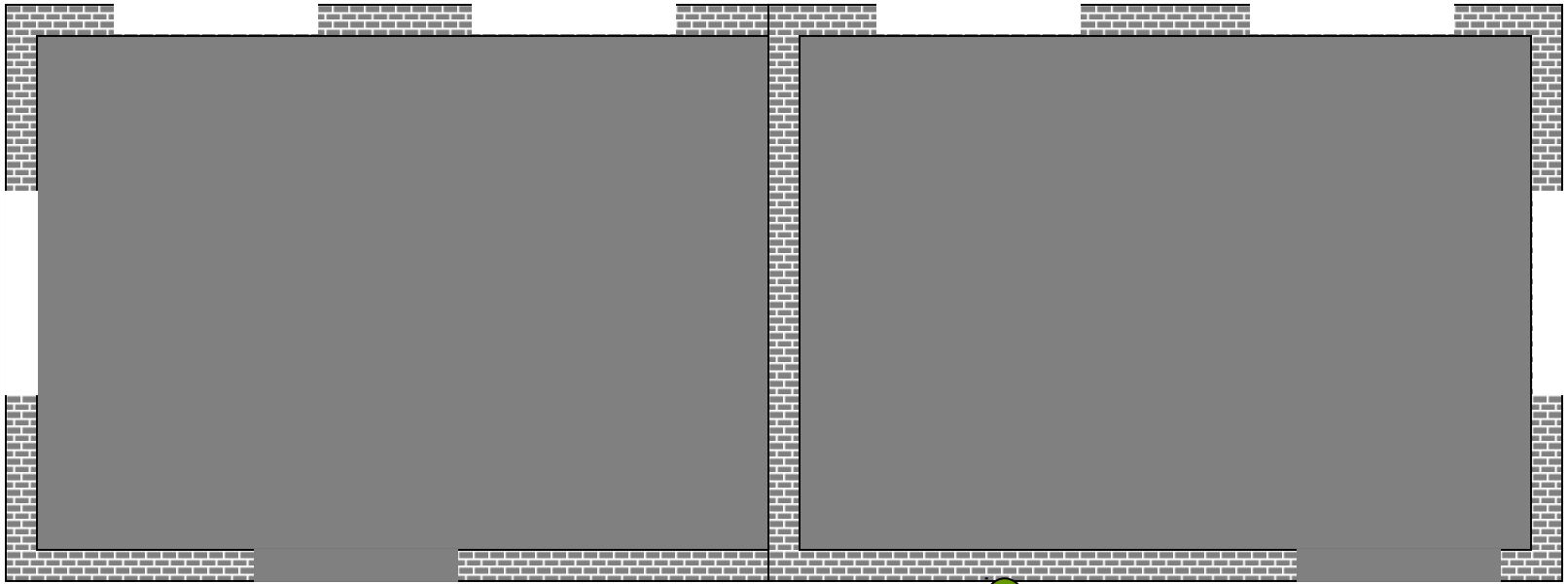

EXECUTION

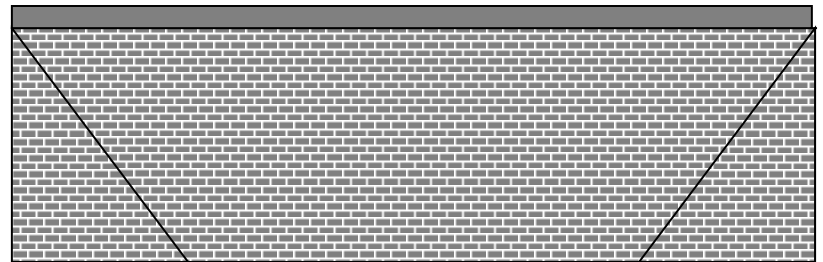
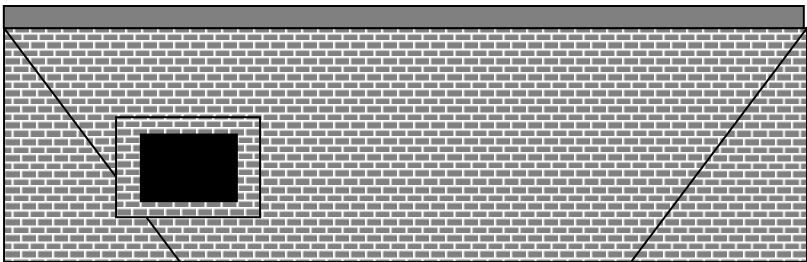
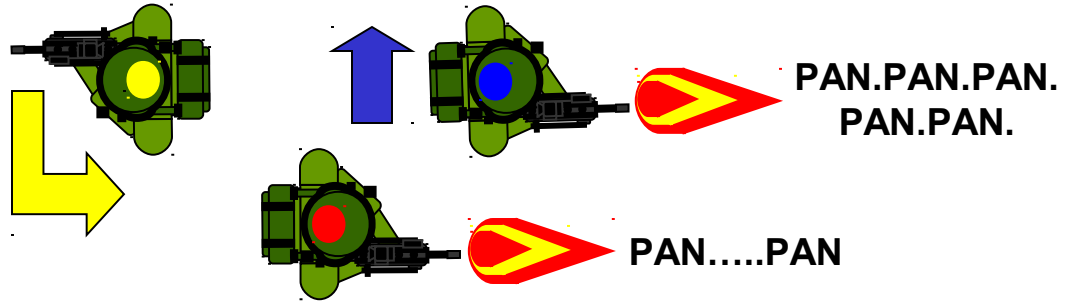
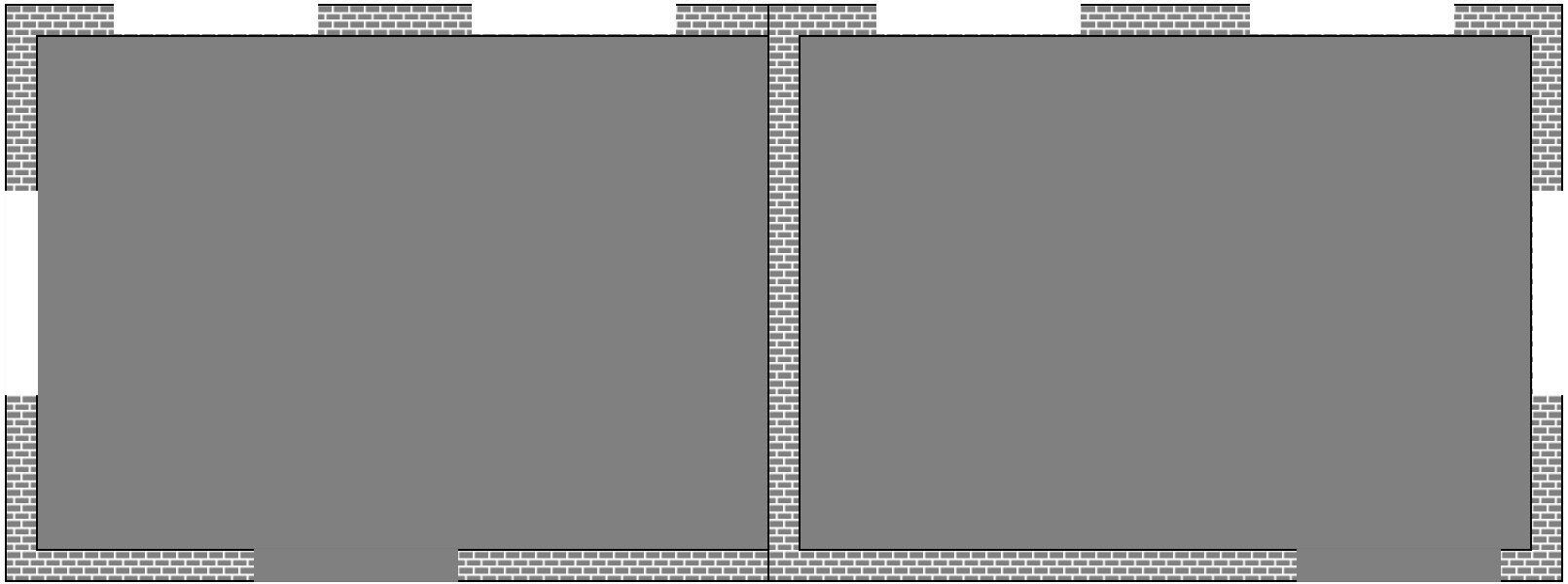

EXECUTION

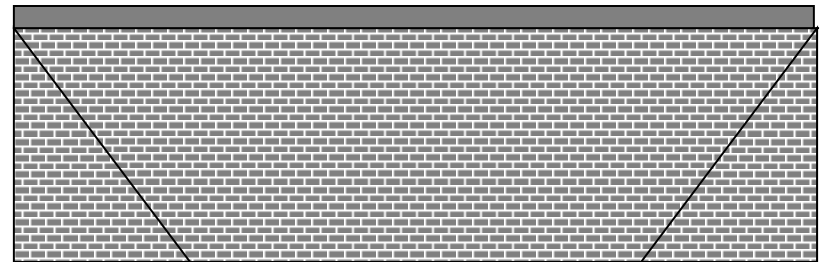
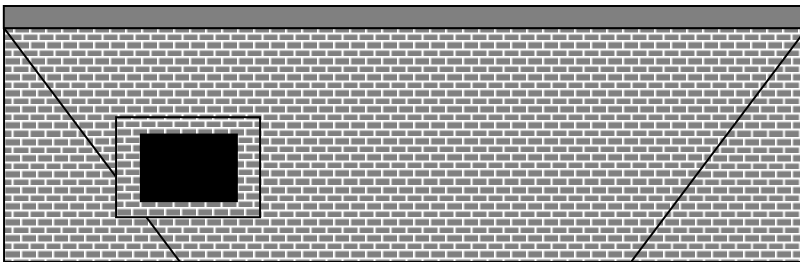
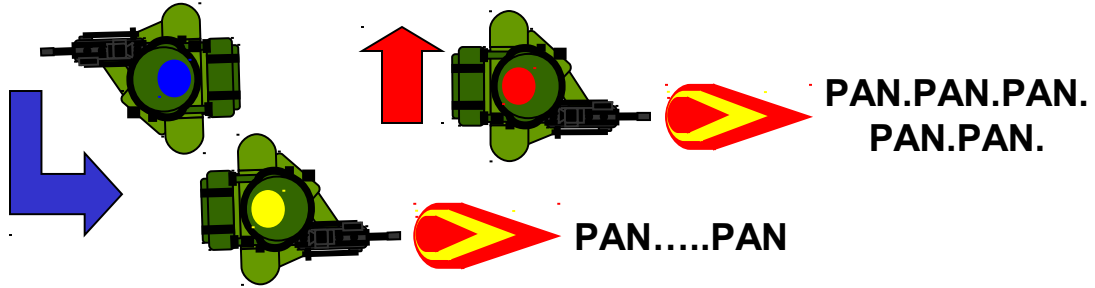
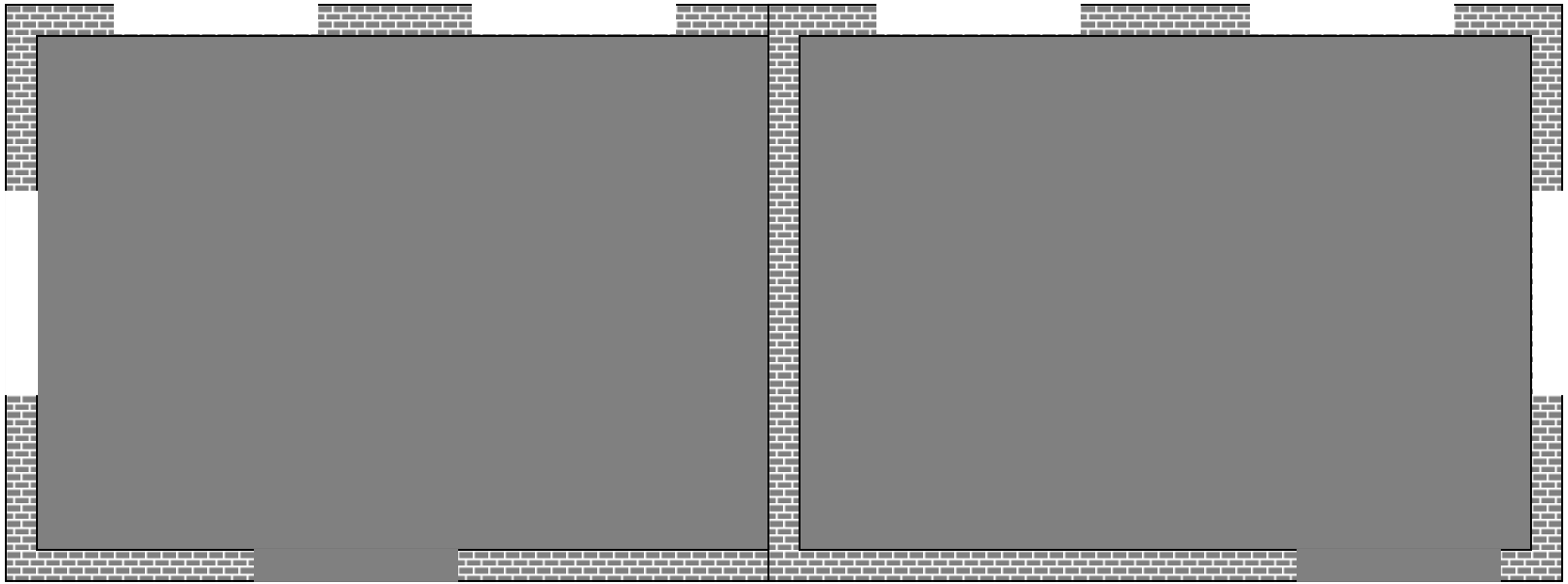

EXECUTION

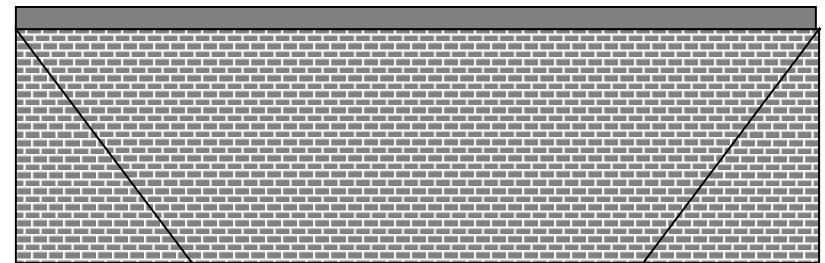
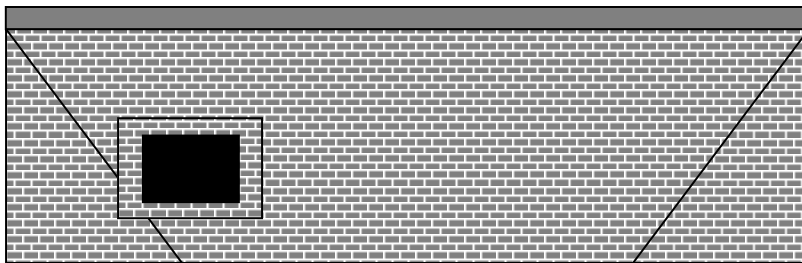
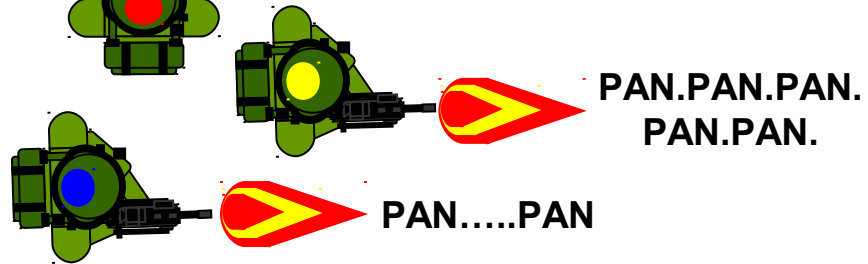
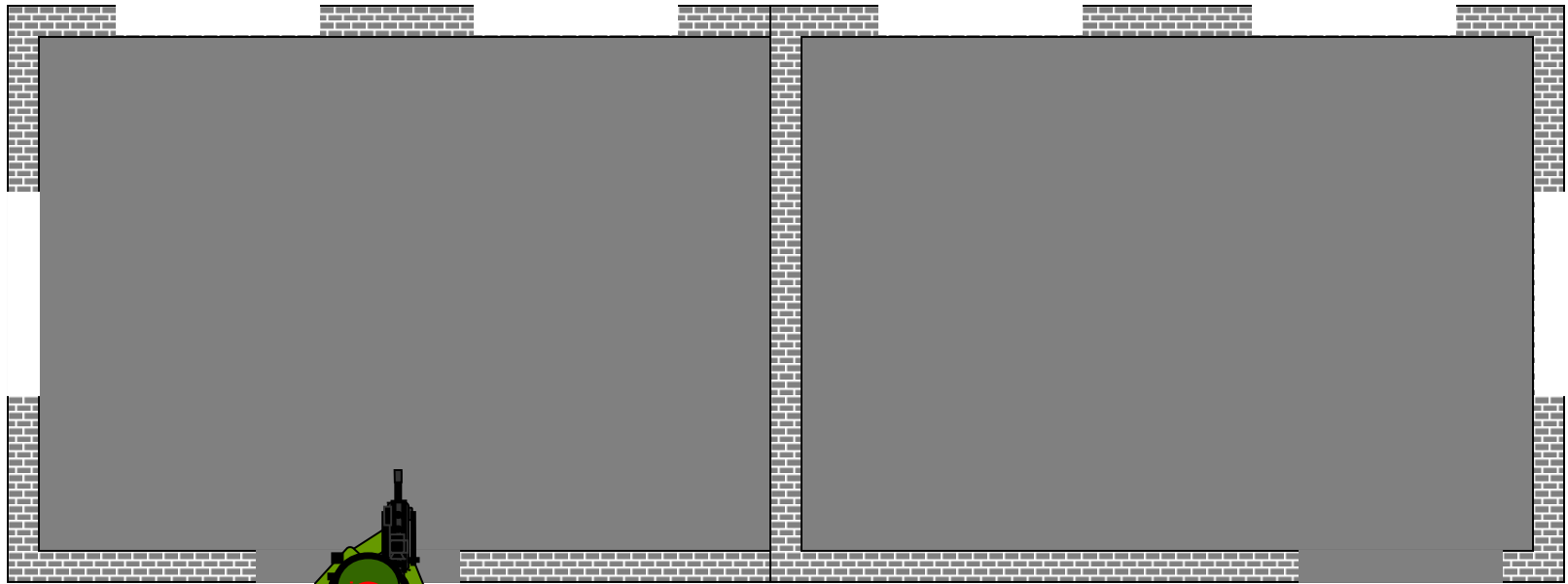

EXECUTION

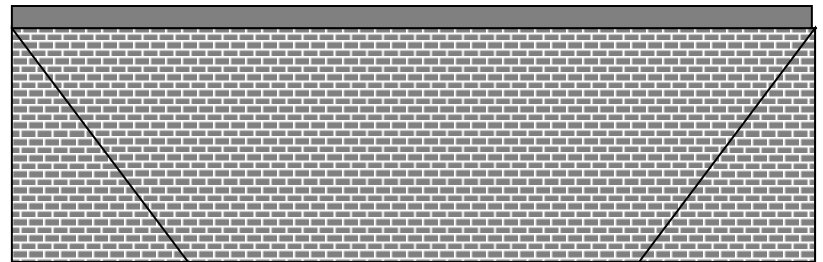
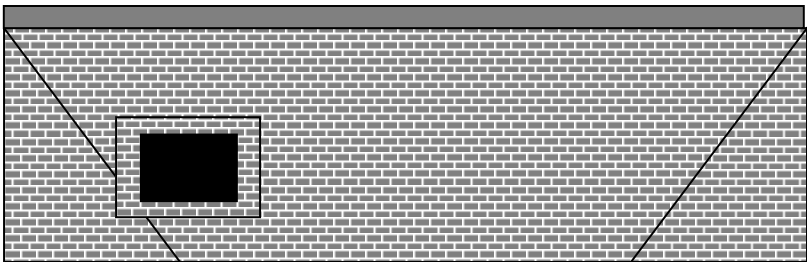
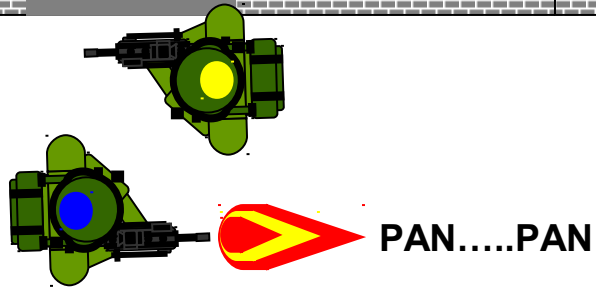
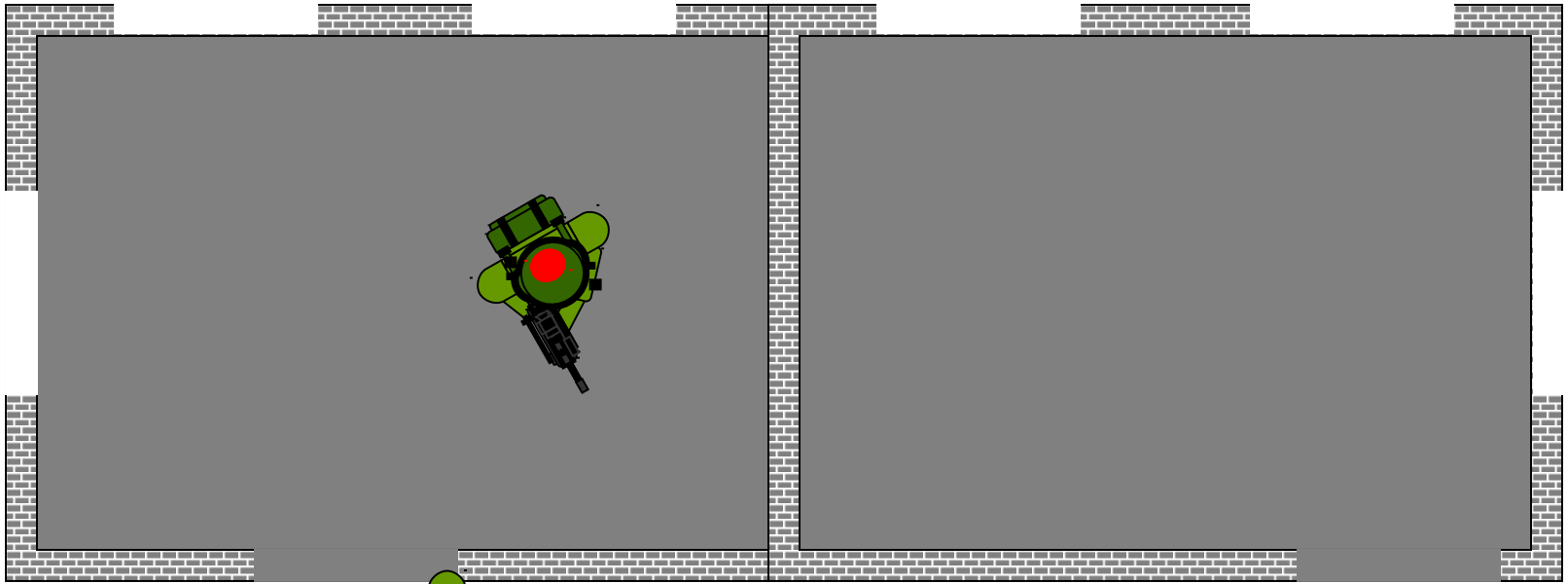

EXECUTION

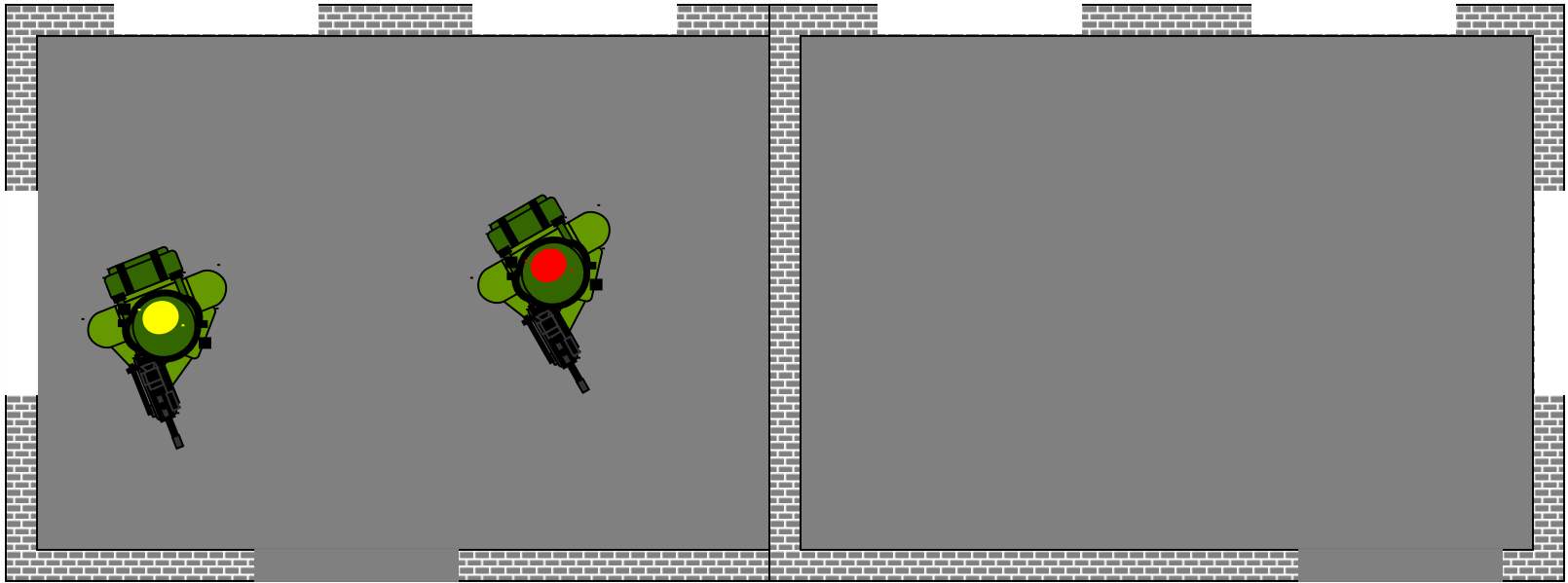

PAN.PAN.PAN.
PAN.PAN.

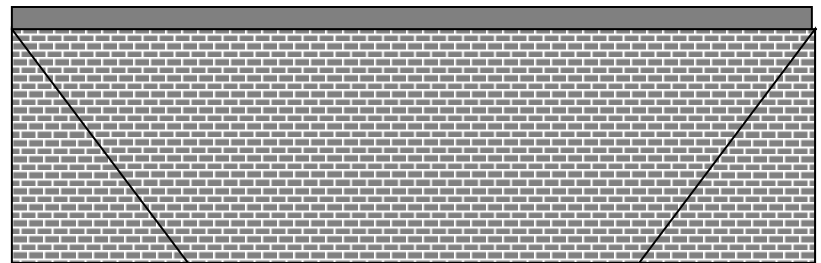
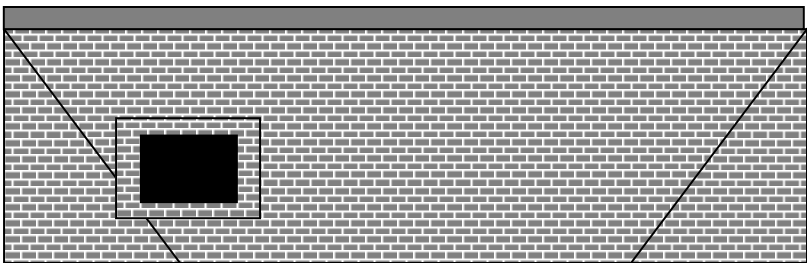

EXECUTION

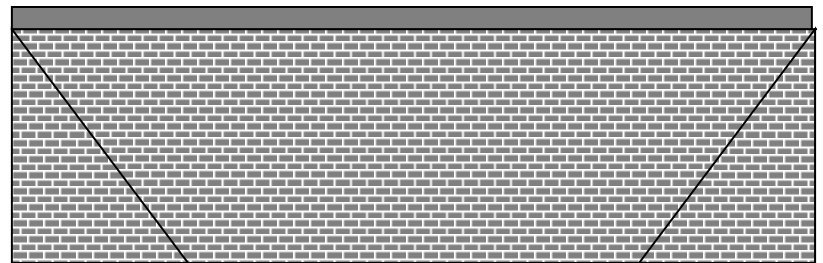
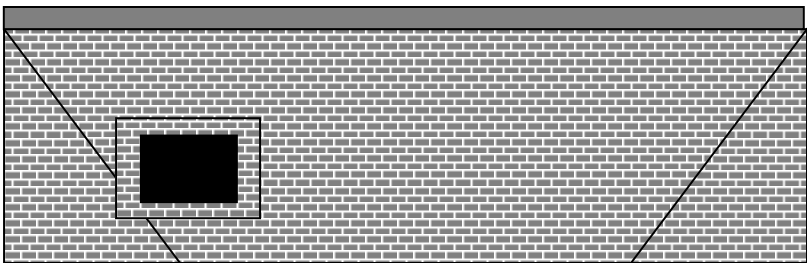
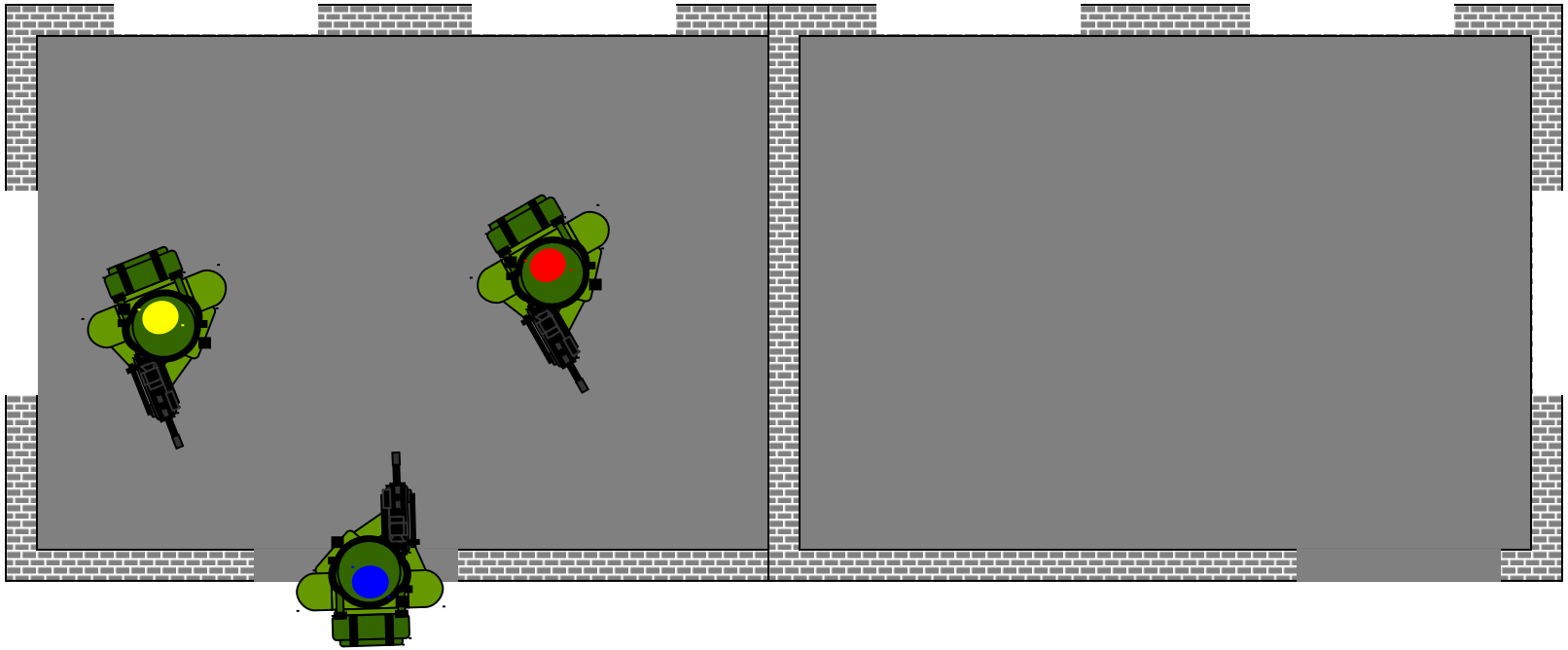

CONTRÔLE PERSONNEL / MUNITIONS

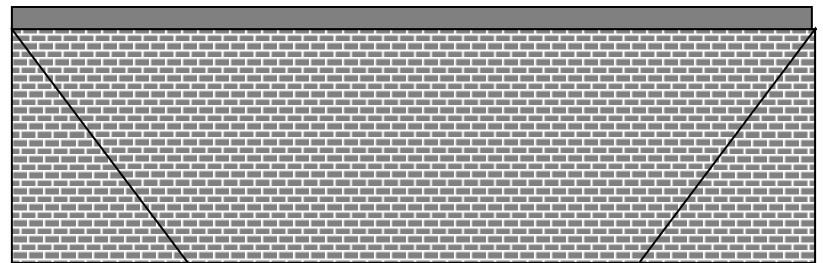
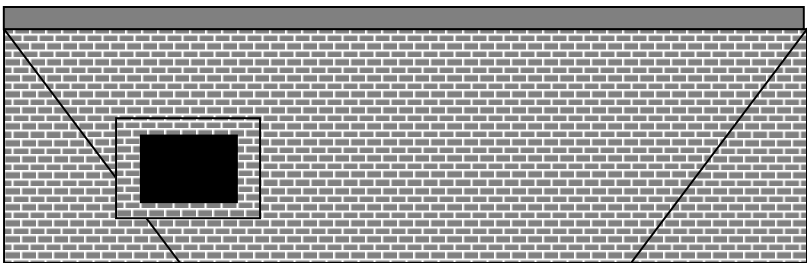
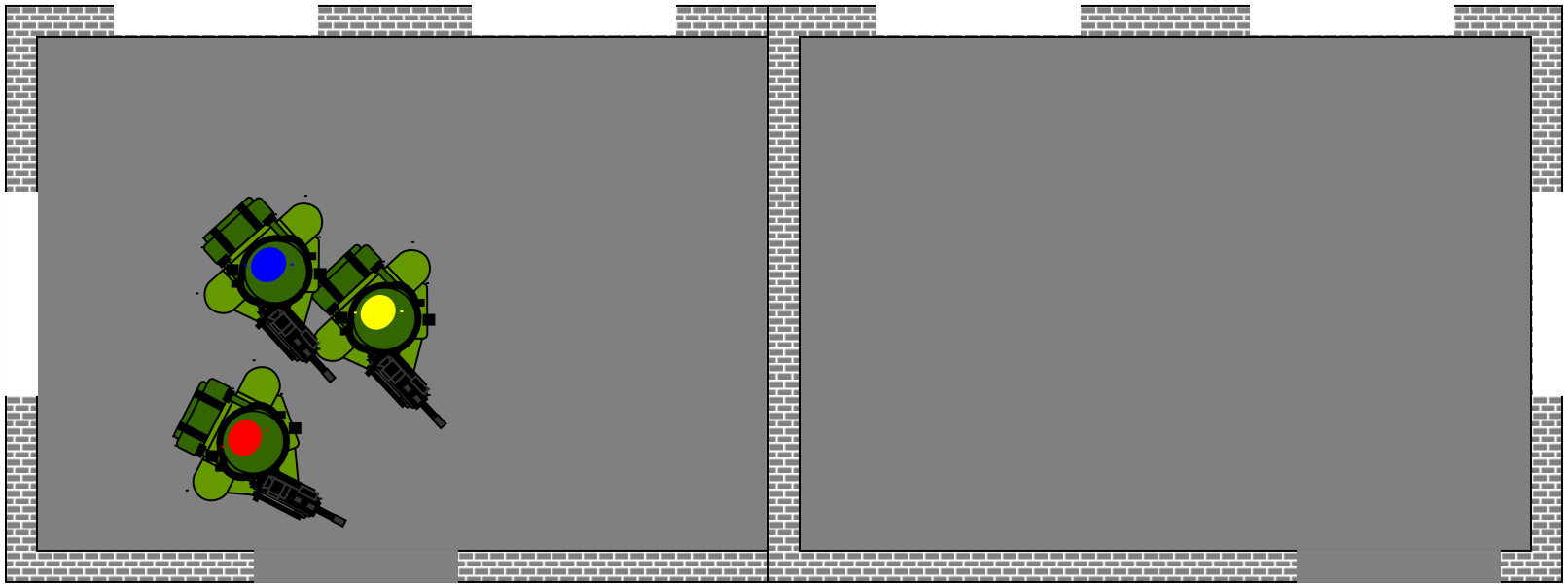

LE TUBE
AVANT

PROGRESSION

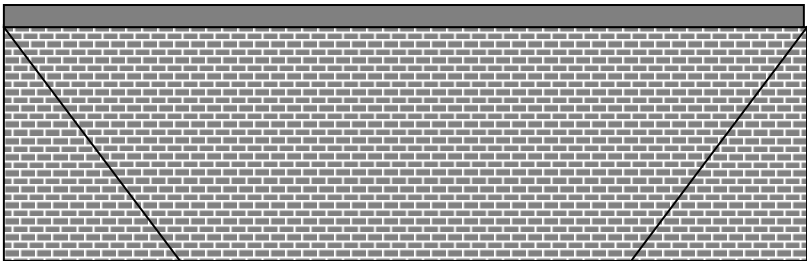
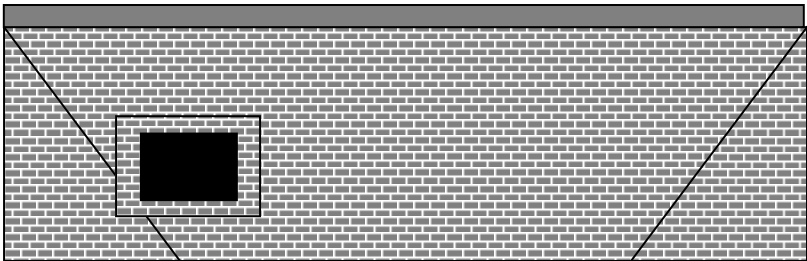
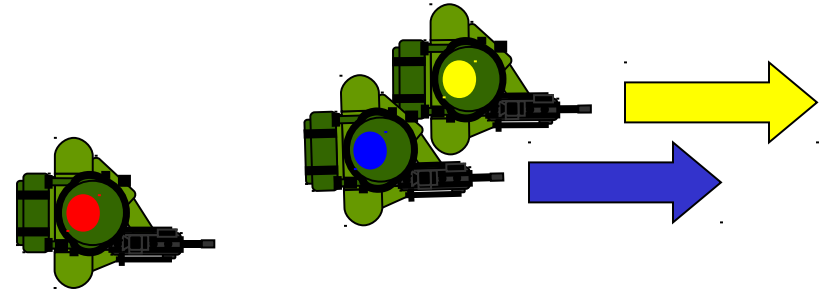
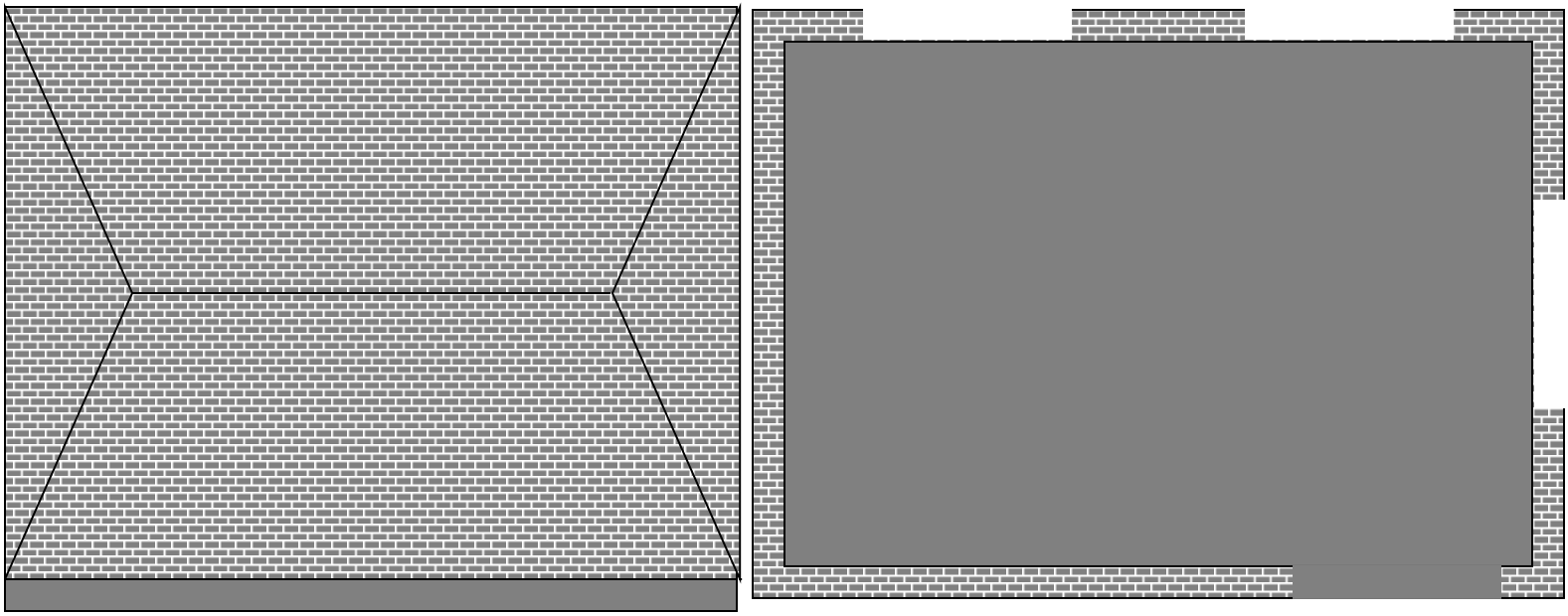

PROGRESSION

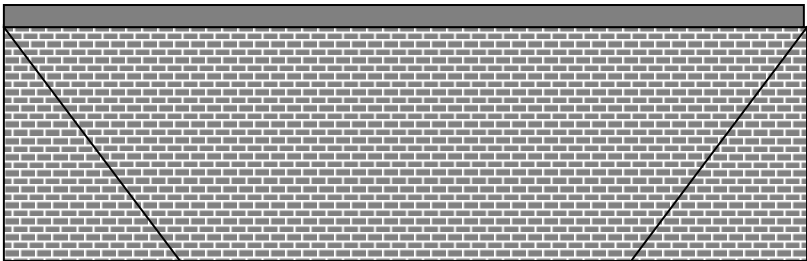
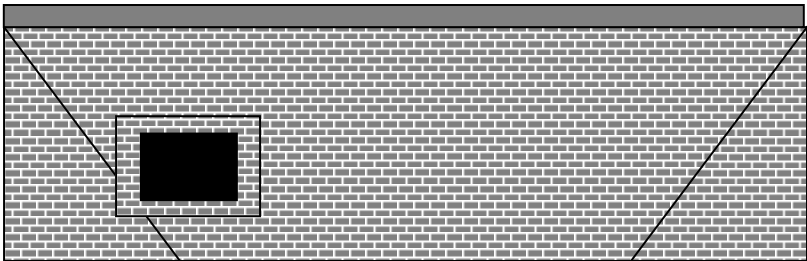
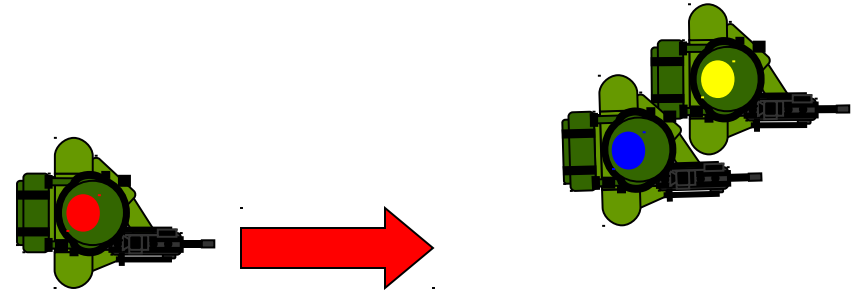
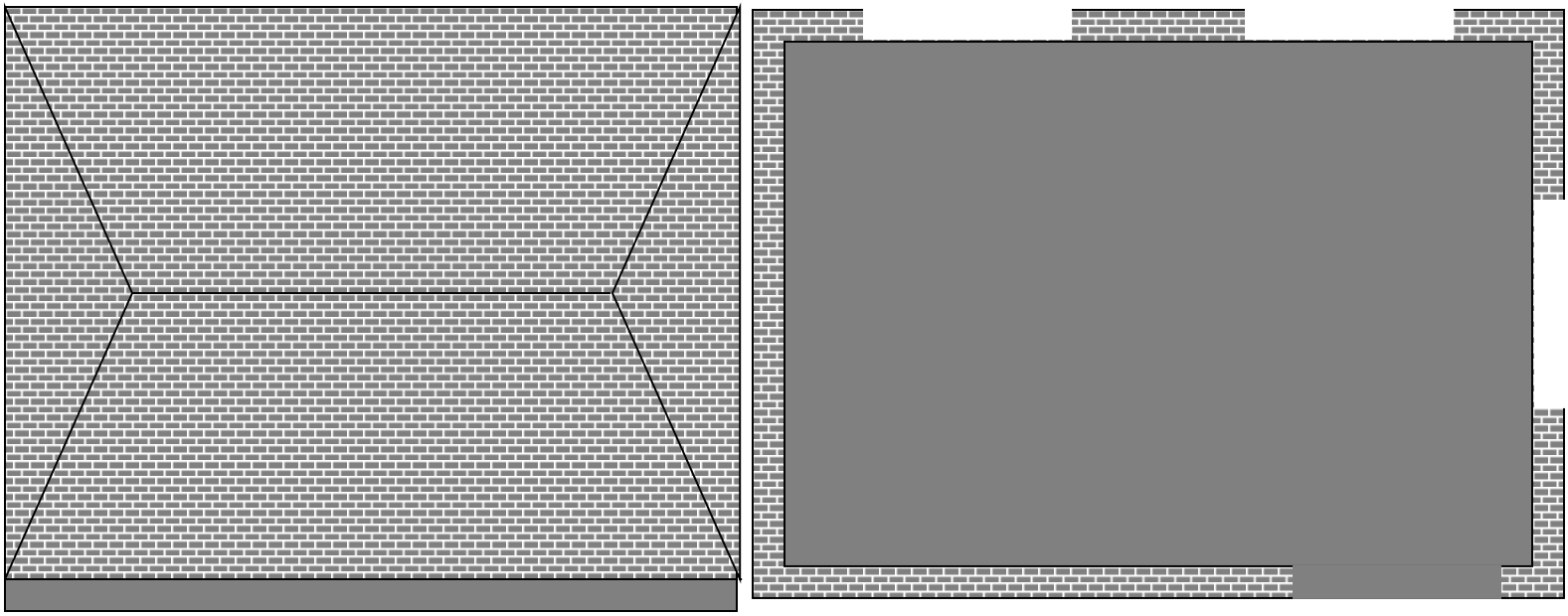

PRISE A PARTIE / ANNONCE / OUVERTURE DU FEU

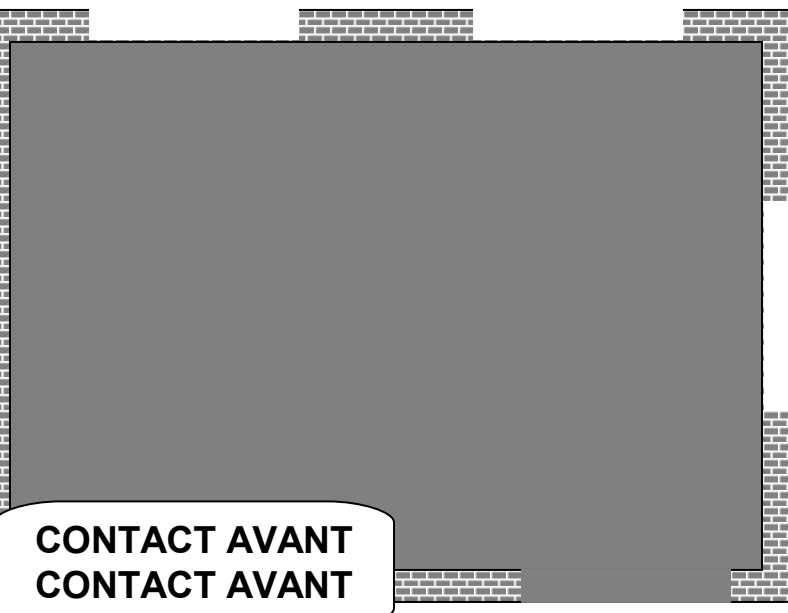
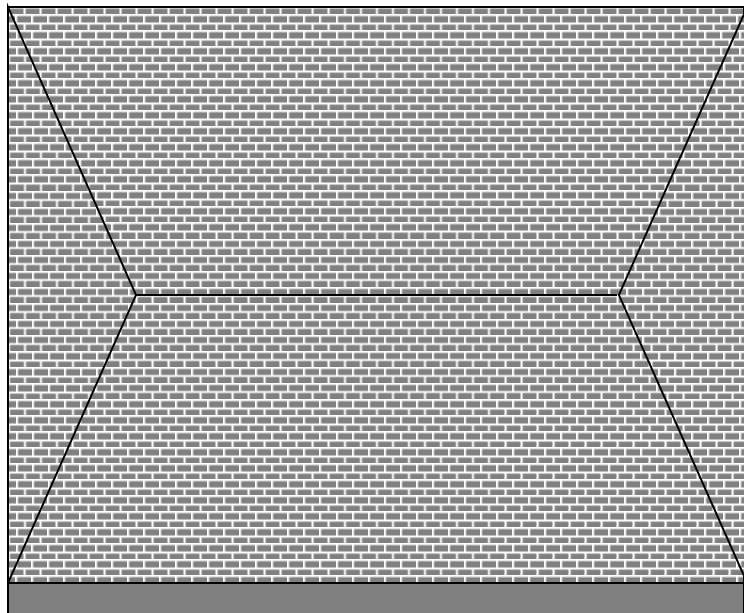

CONTACT AVANT
CONTACT AVANT

CONTACT AVANT
CONTACT AVANT

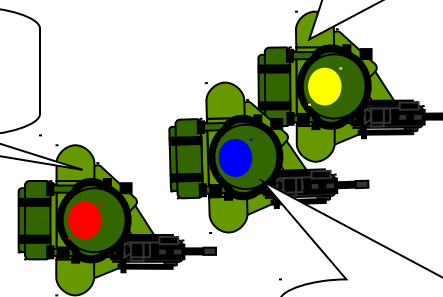

PAN....PAN



CONTACT AVANT
CONTACT AVANT

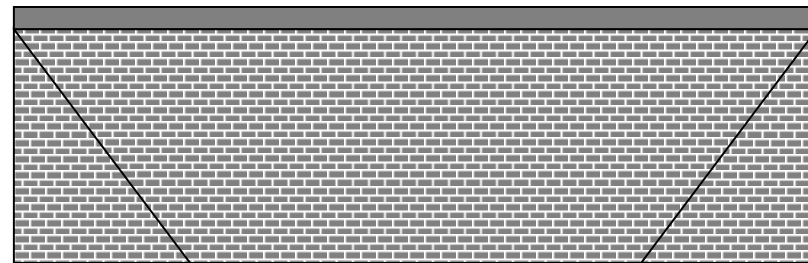
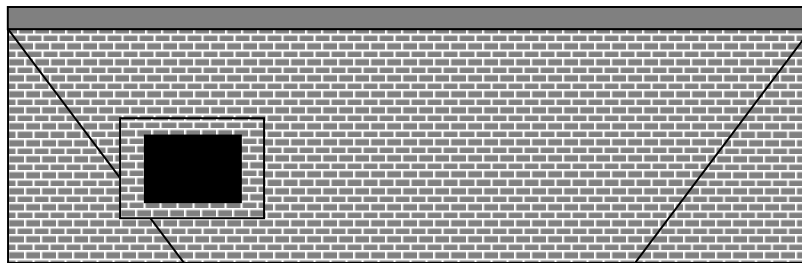

PRISE DE DECISION / REPERCUTION

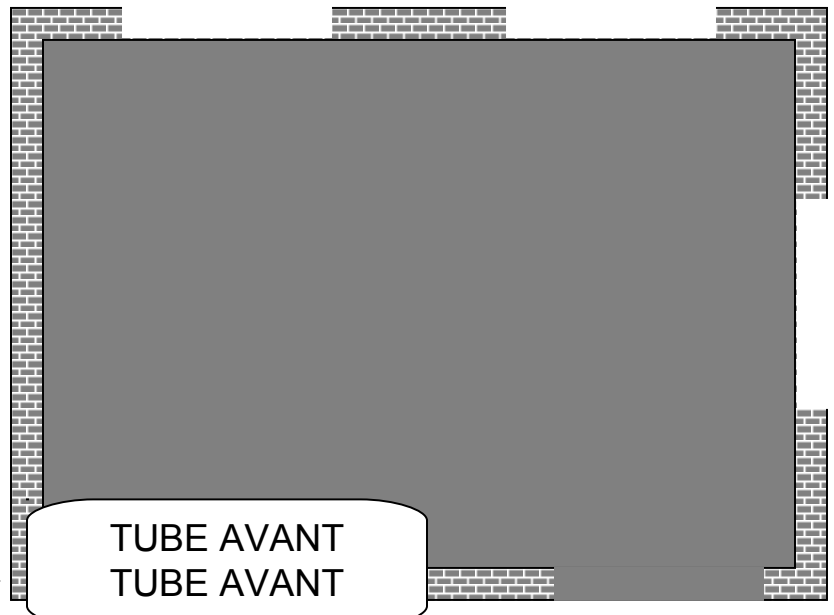
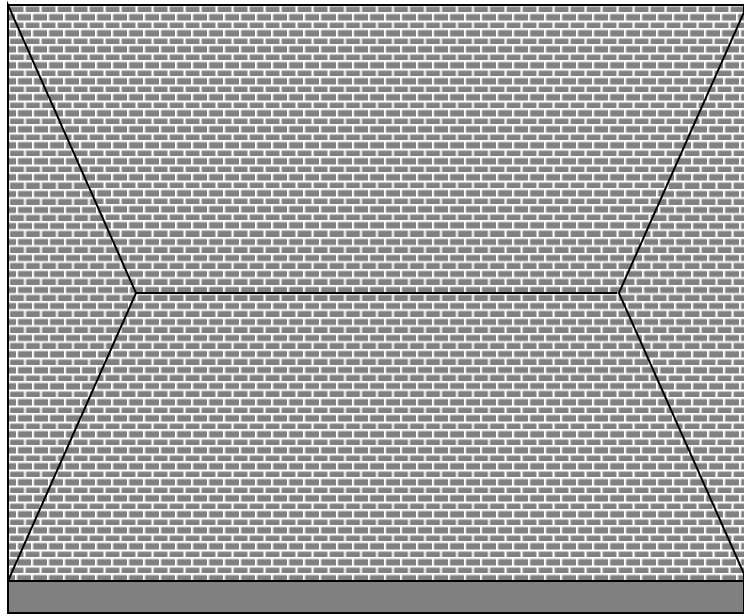

TUBE AVANT
TUBE AVANT

TUBE AVANT
TUBE AVANT

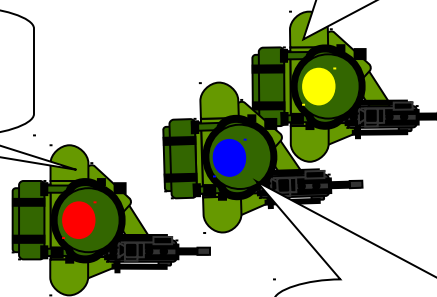

TUBE AVANT
TUBE AVANT

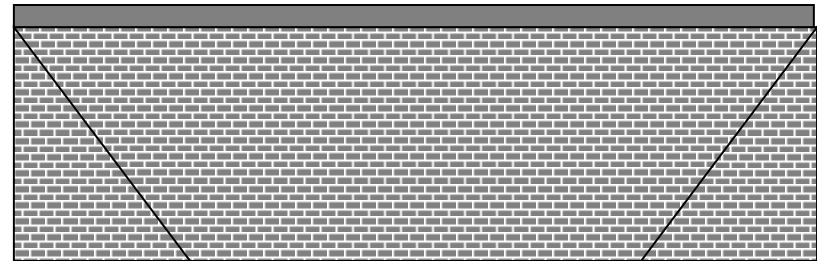
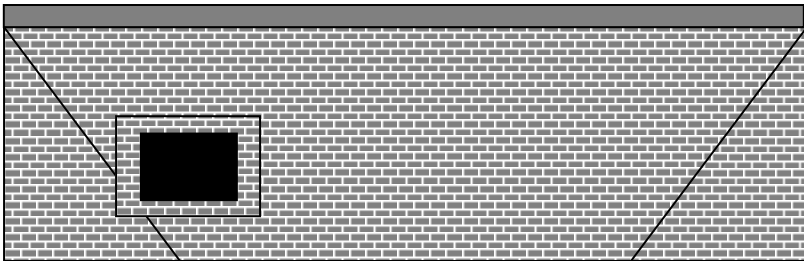

EXECUTION

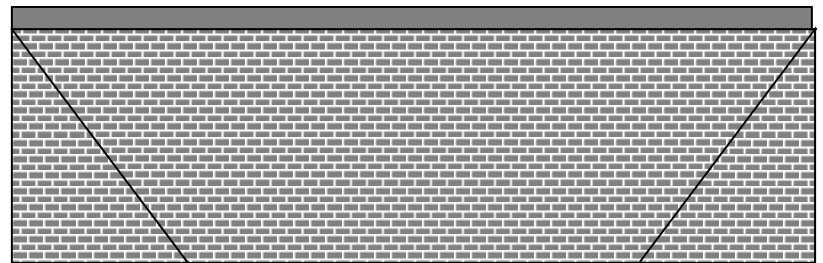
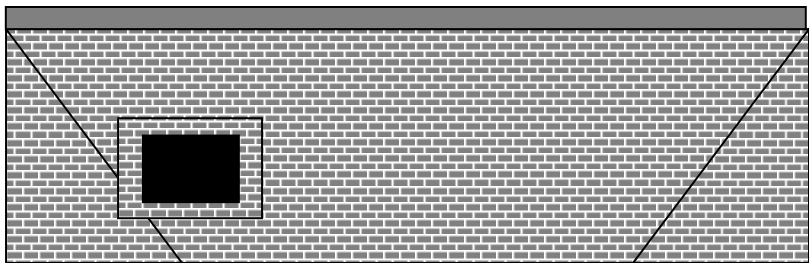
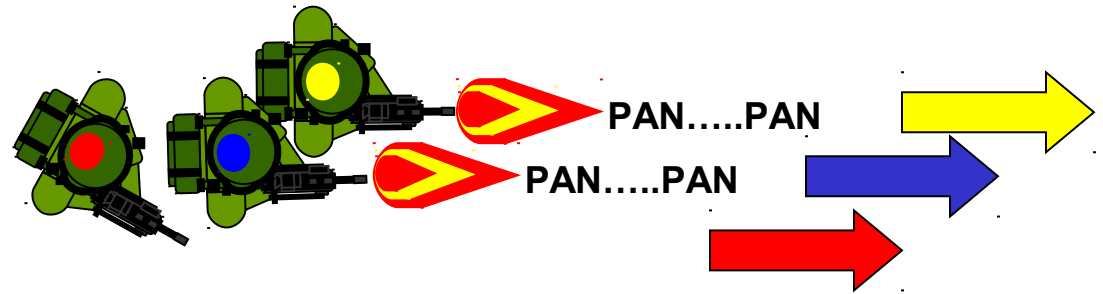
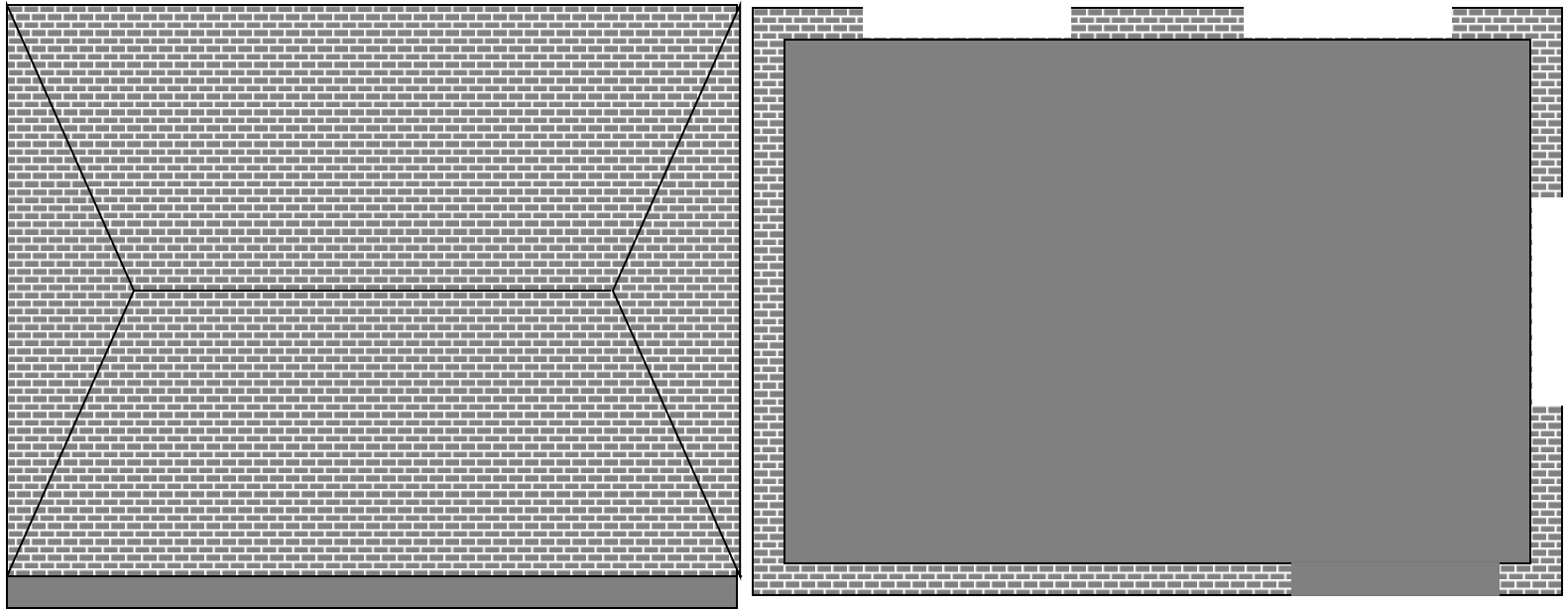

EXECUTION

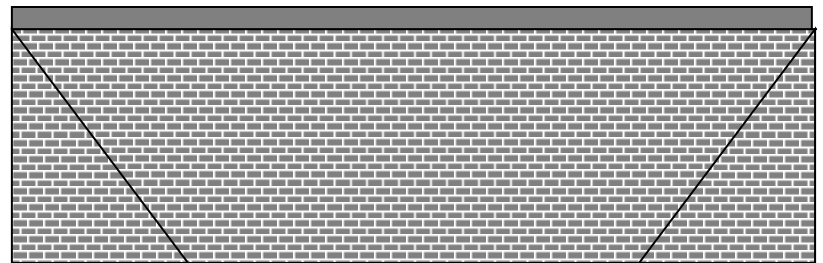
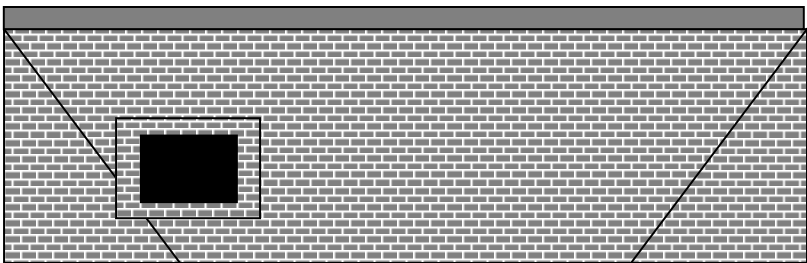
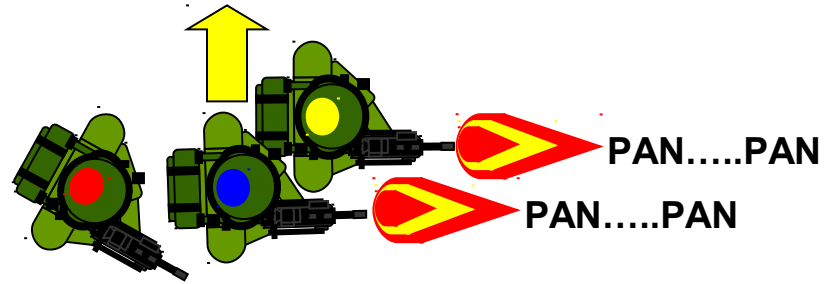
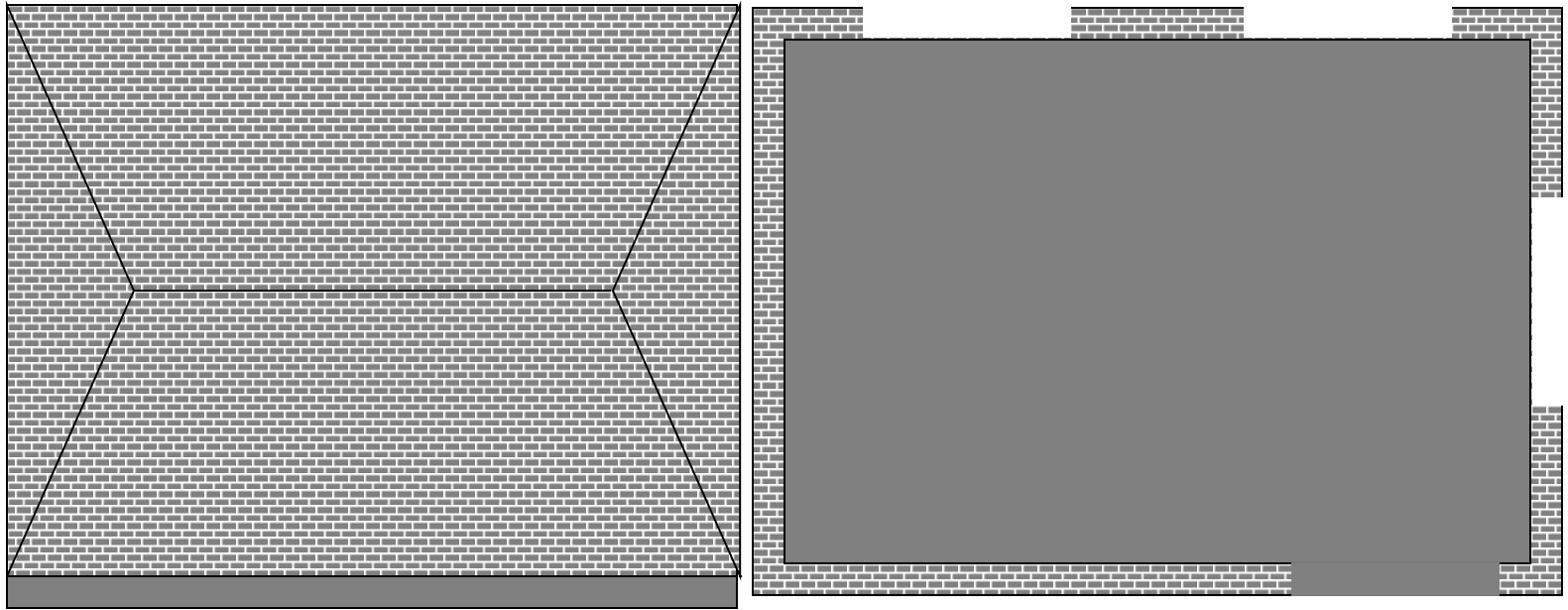

EXECUTION

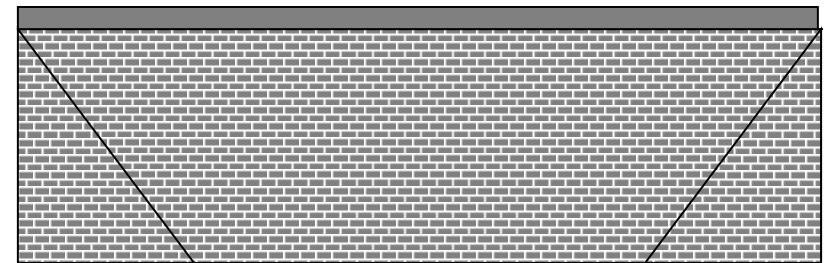
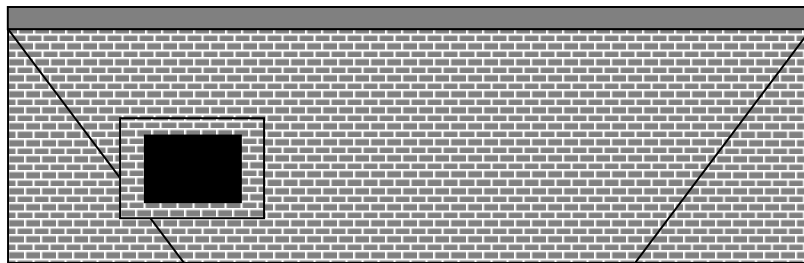
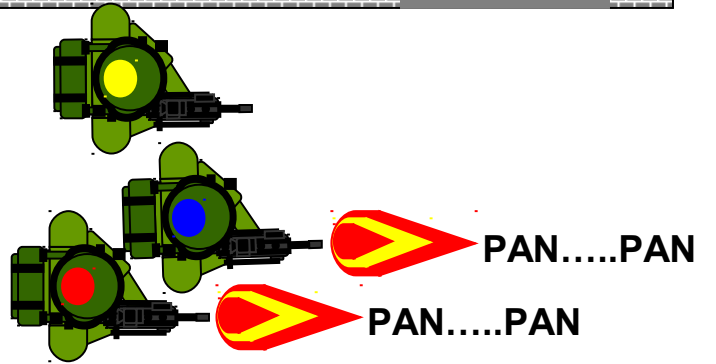
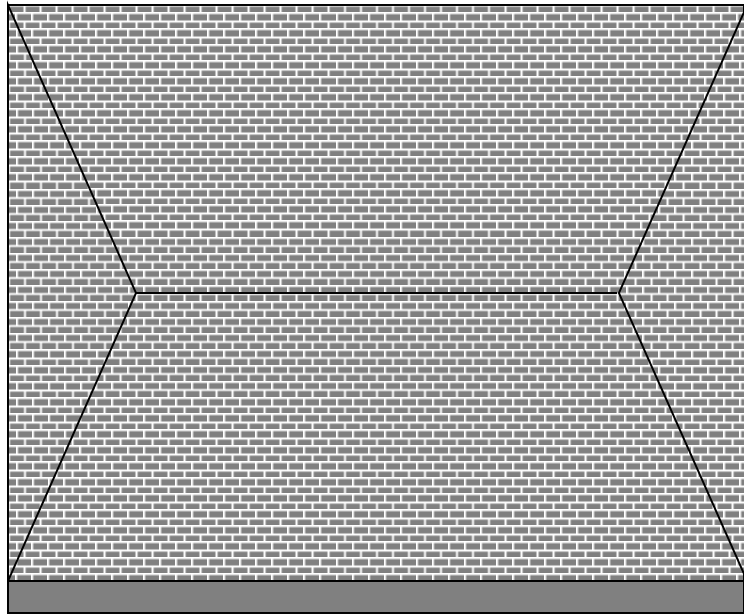

EXECUTION

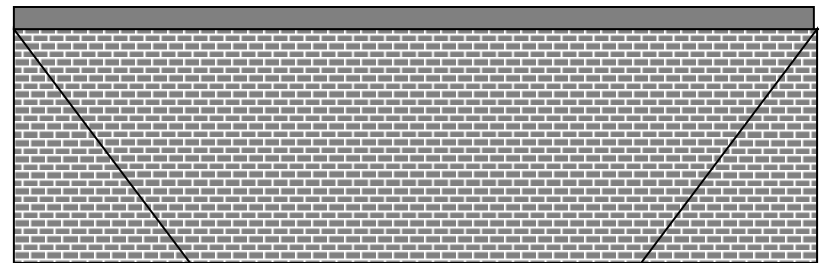
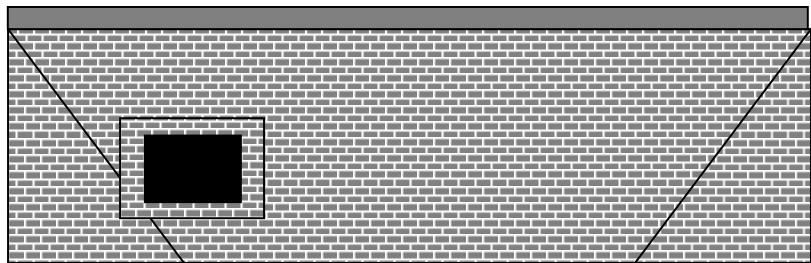
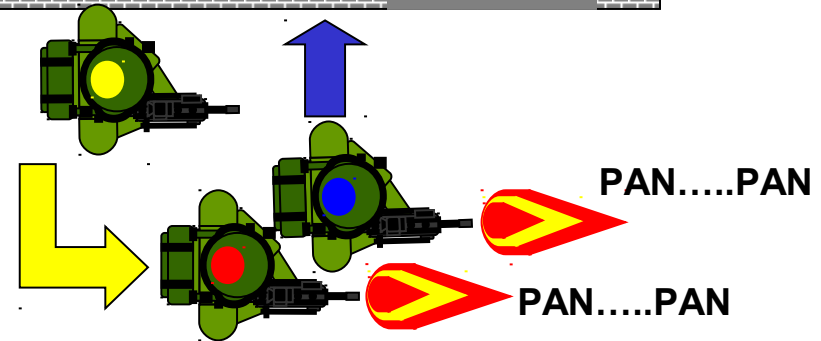
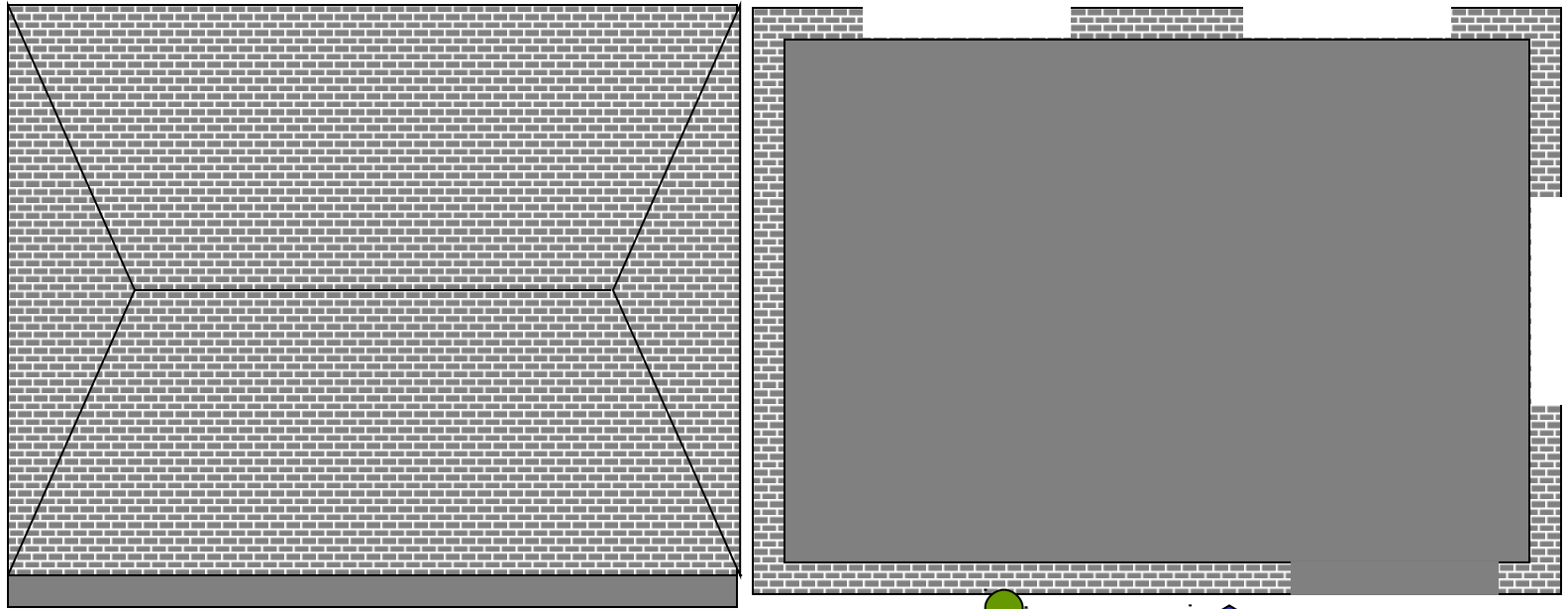

EXECUTION

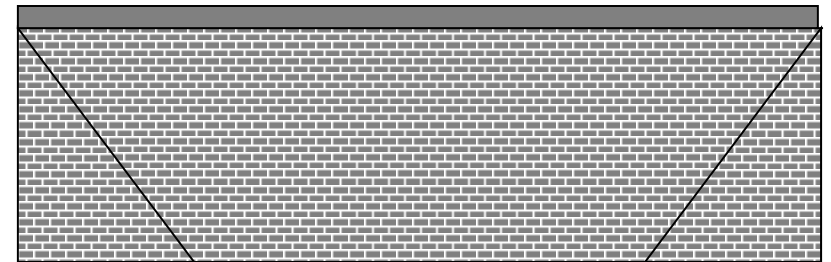
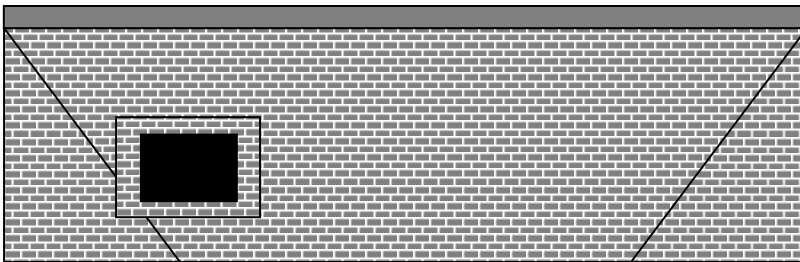
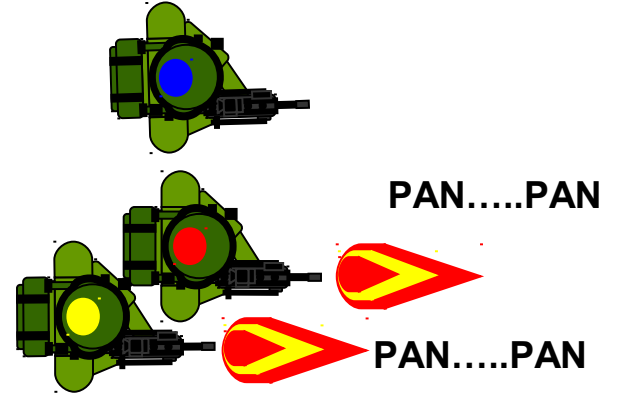
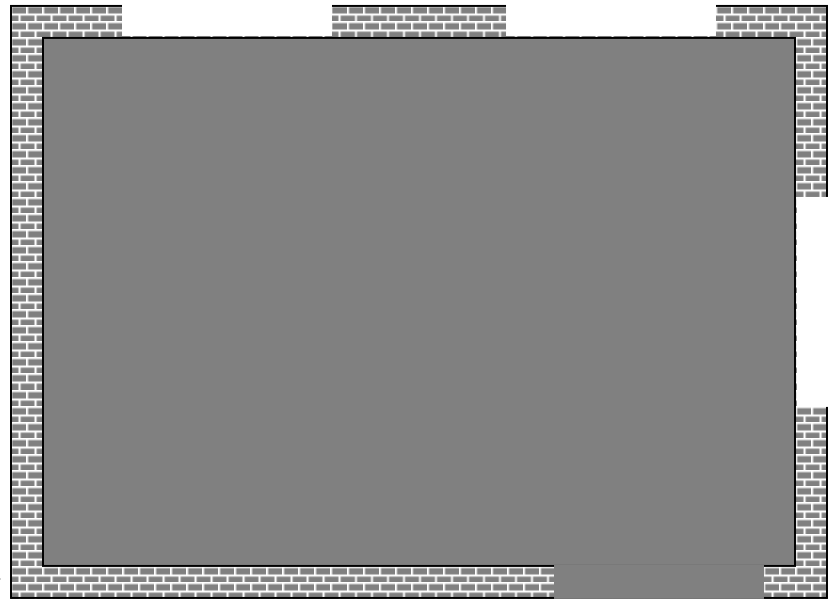
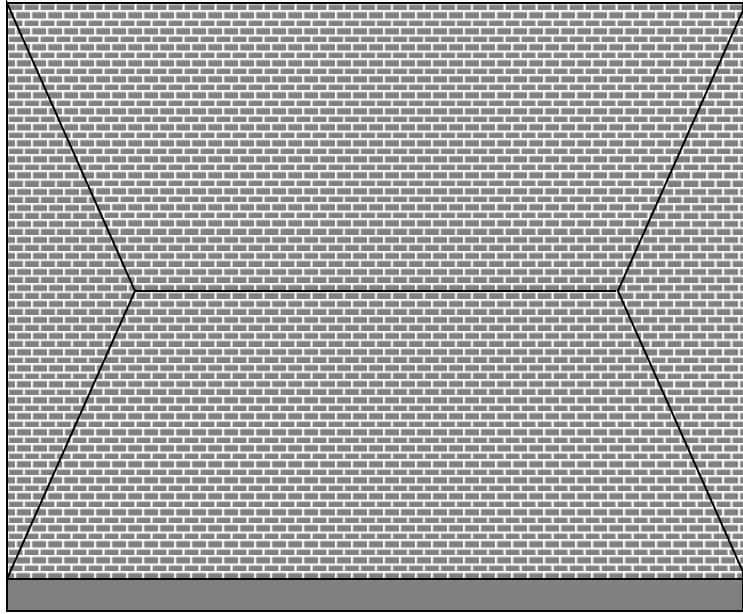

EXECUTION

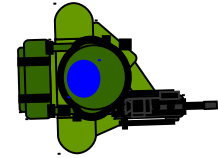
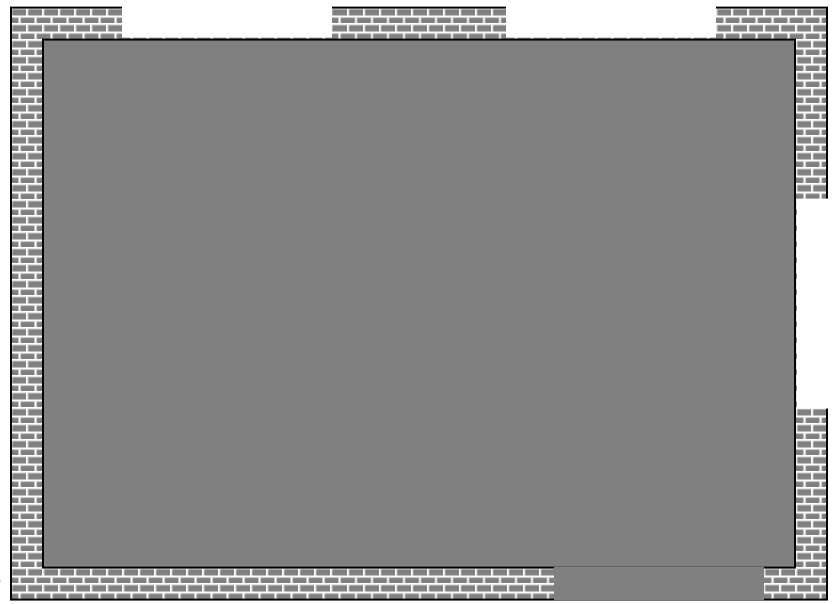
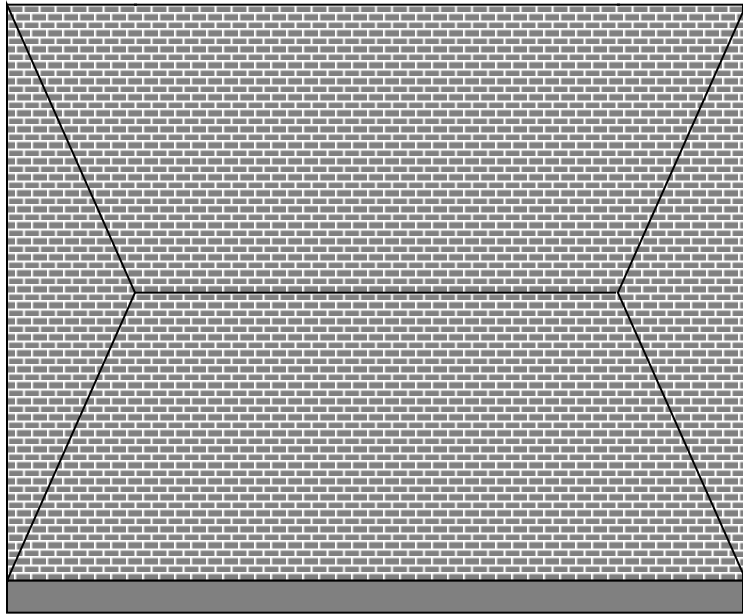

PAN....PAN

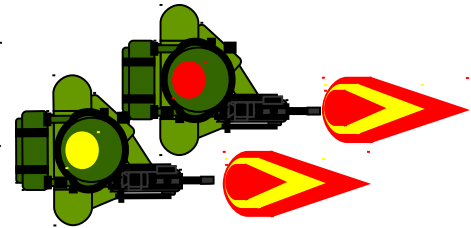
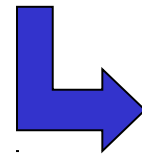

PAN....PAN

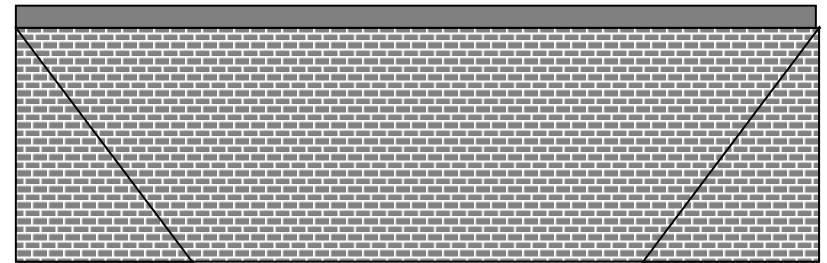
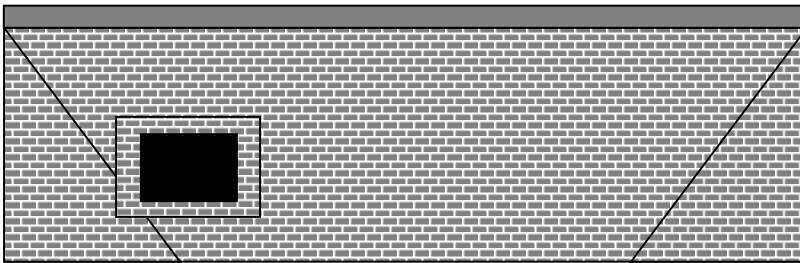

EXECUTION

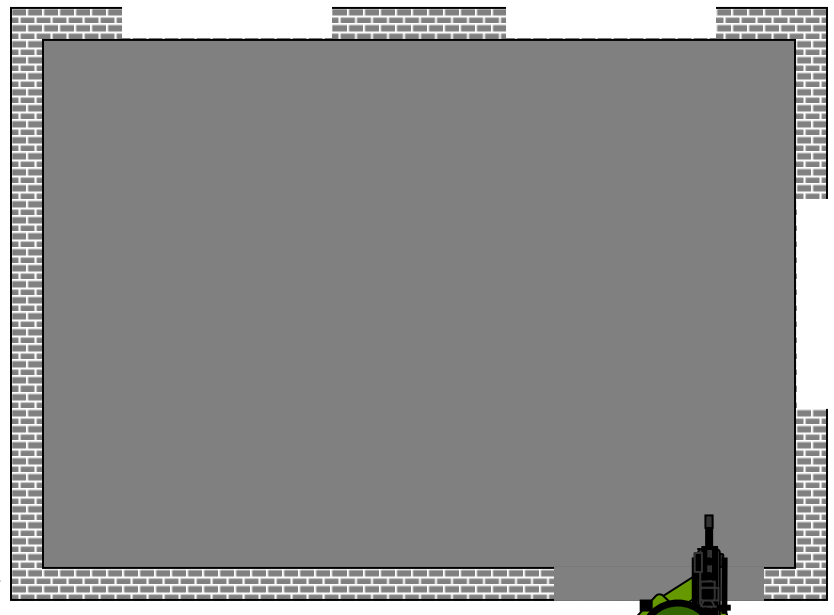
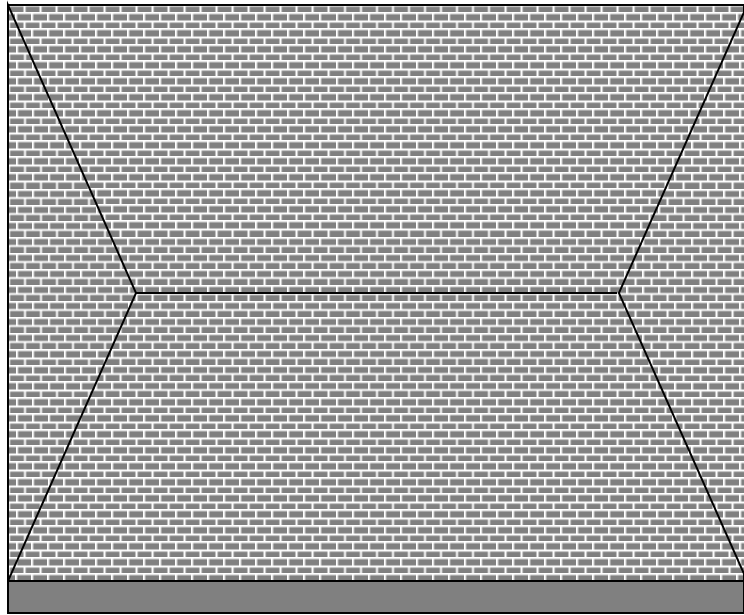

PAN....PAN

PAN....PAN

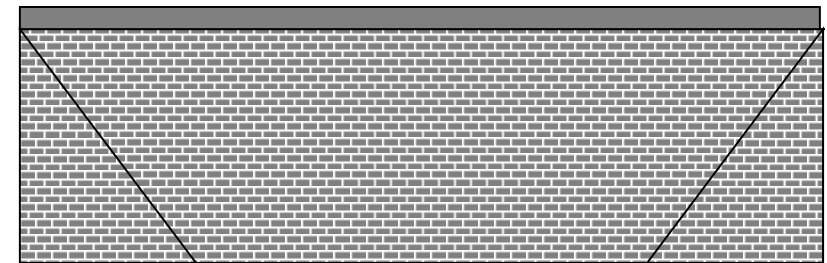
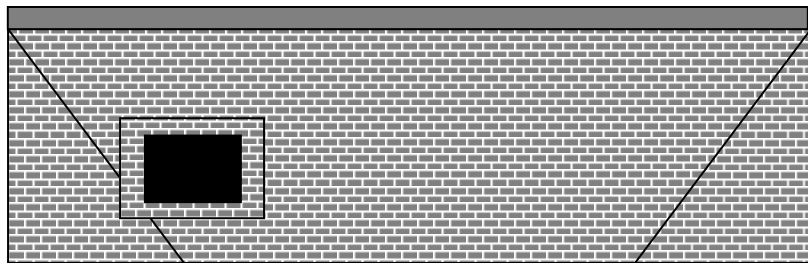

EXECUTION

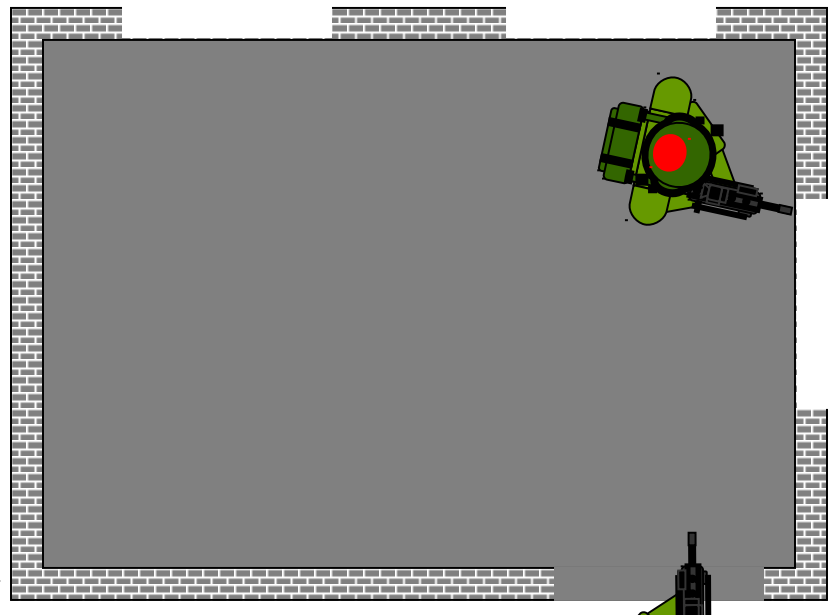
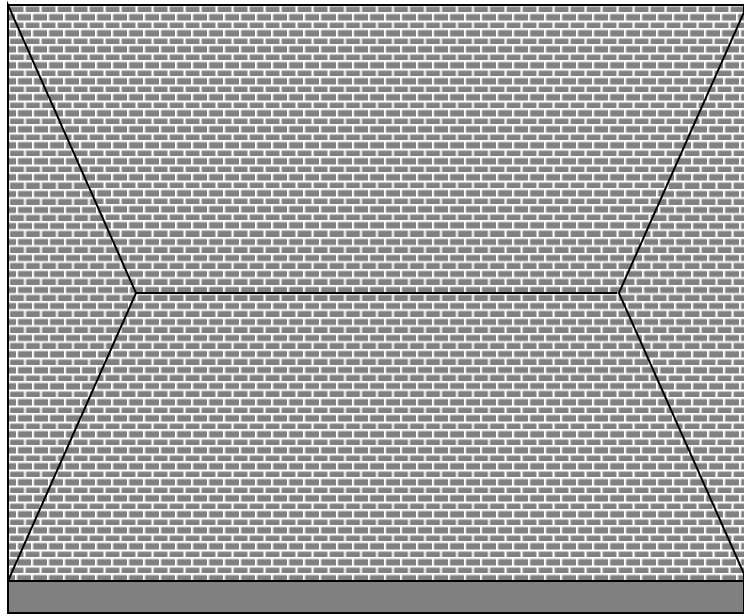

PAN....PAN

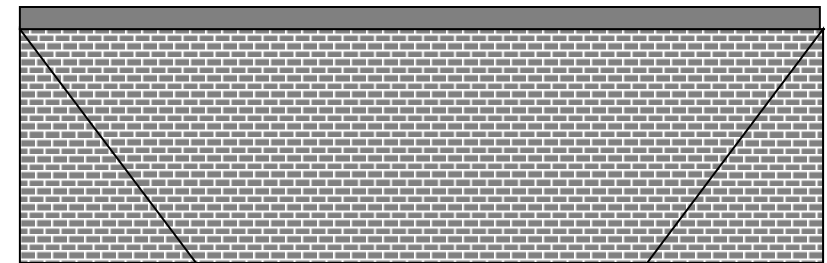
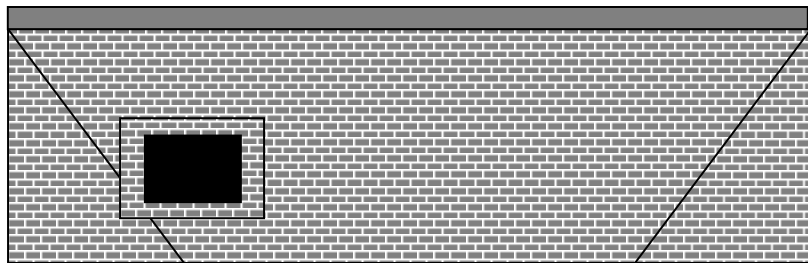

EXECUTION

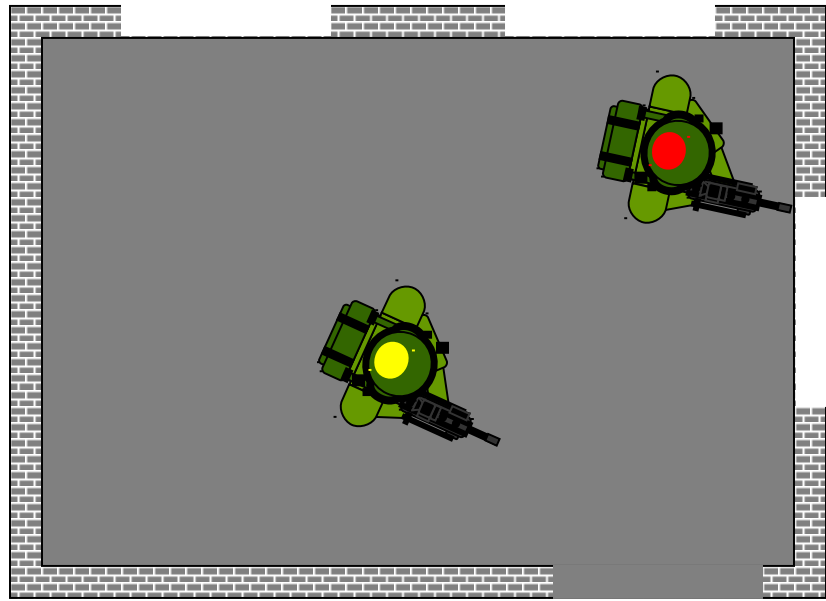
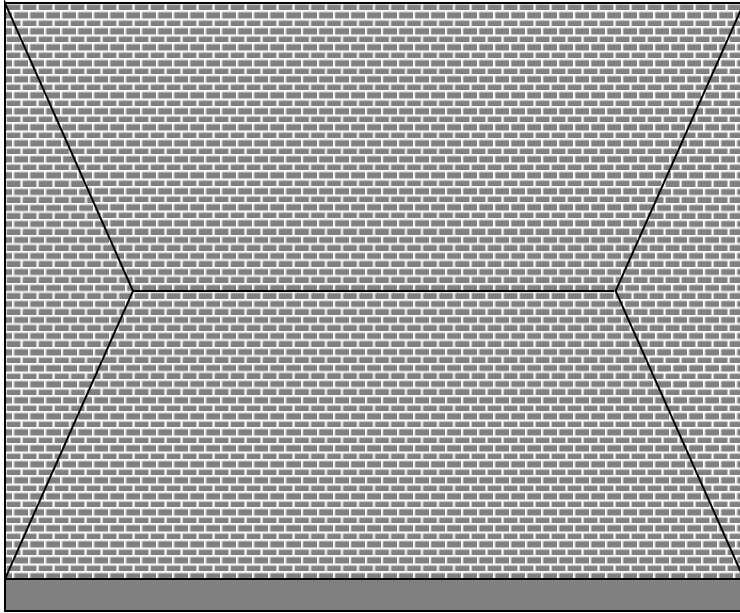

PAN.PAN.PAN.
PAN.PAN.

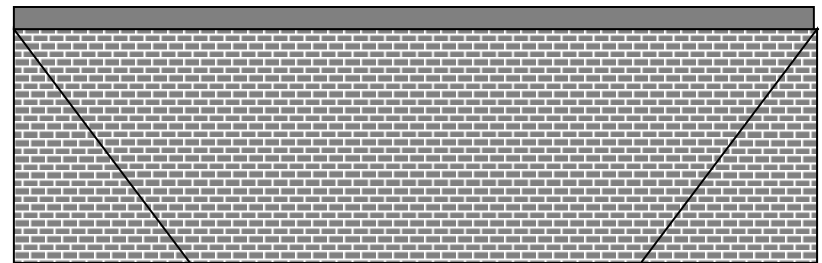
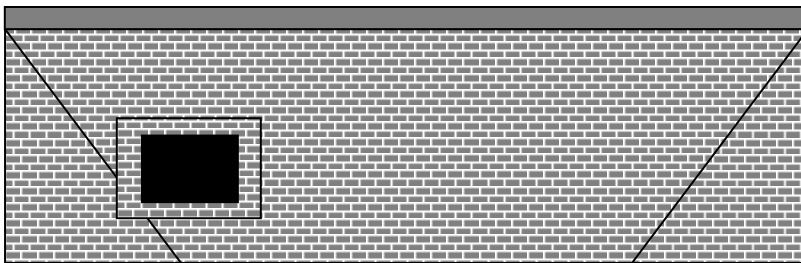

EXECUTION

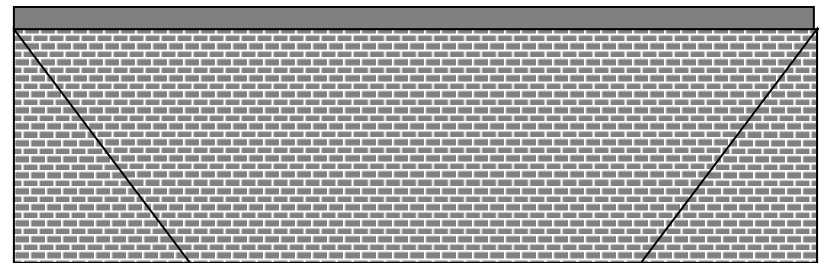
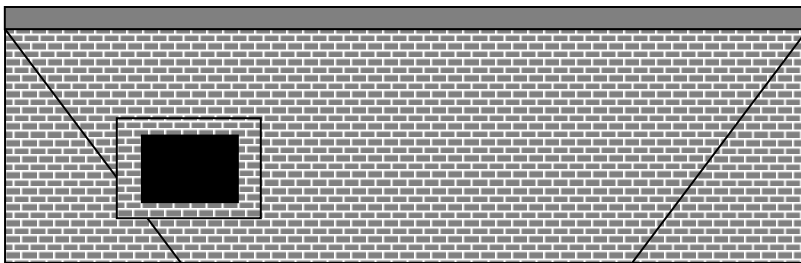
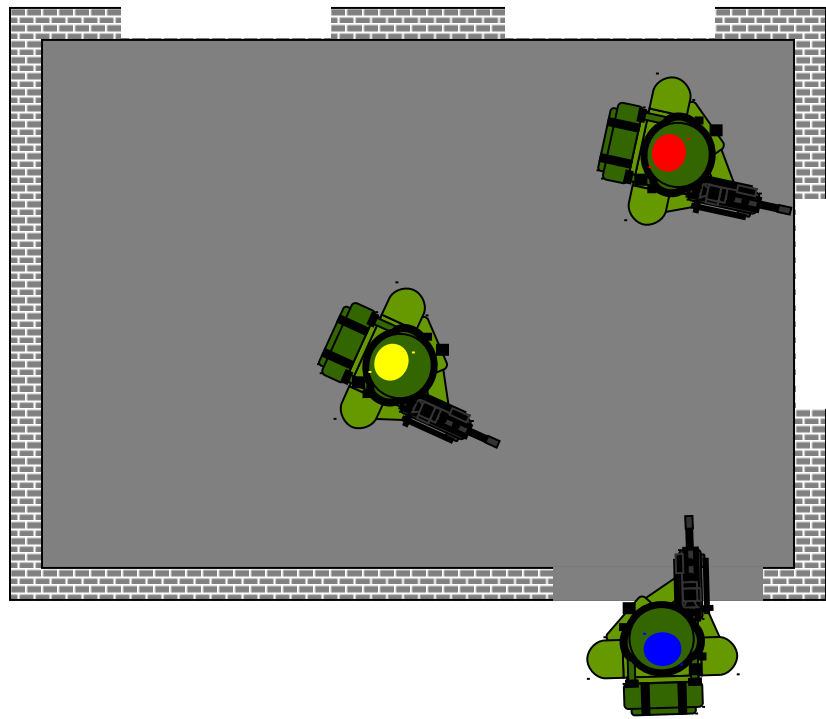
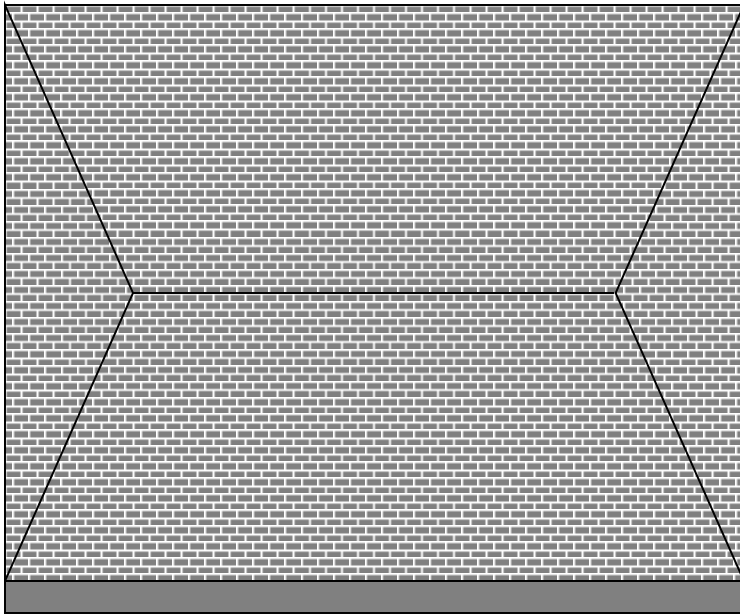

CONTRÔLE PERSONNEL / MUNITIONS

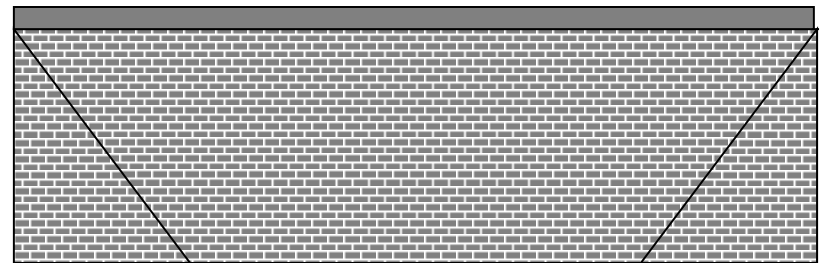
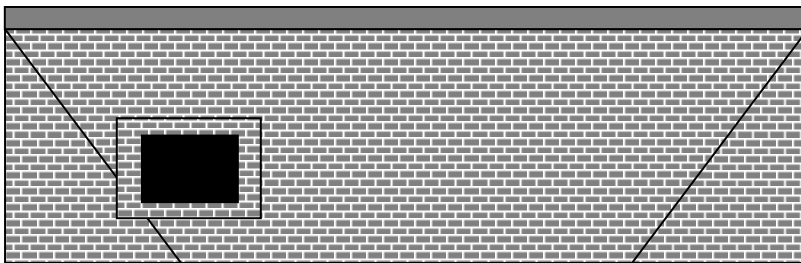
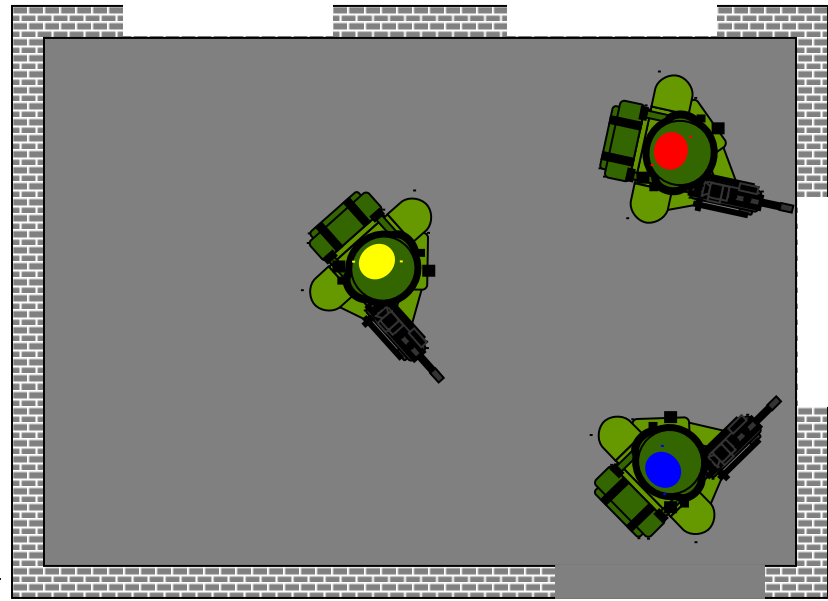
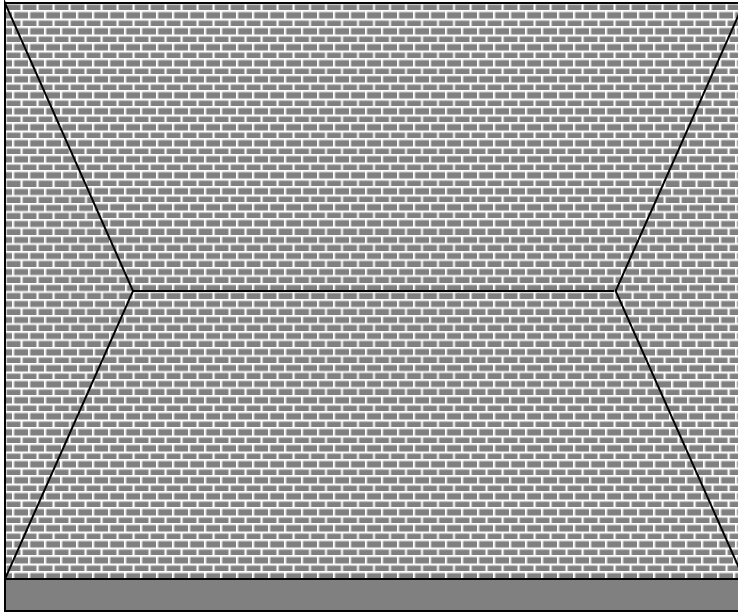

**RELEVE
DE BLESSE
SOUS LE FEU**

SORTIE

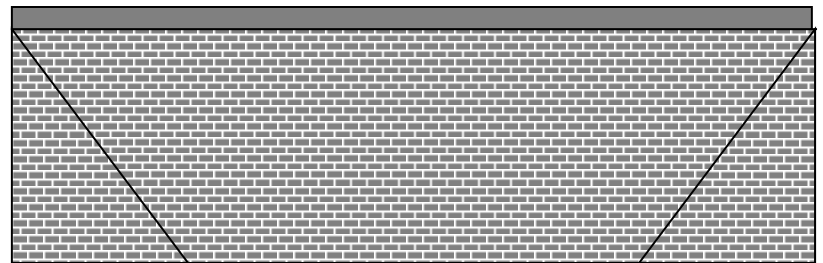
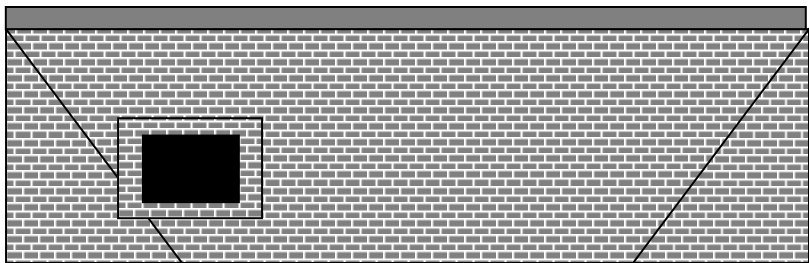
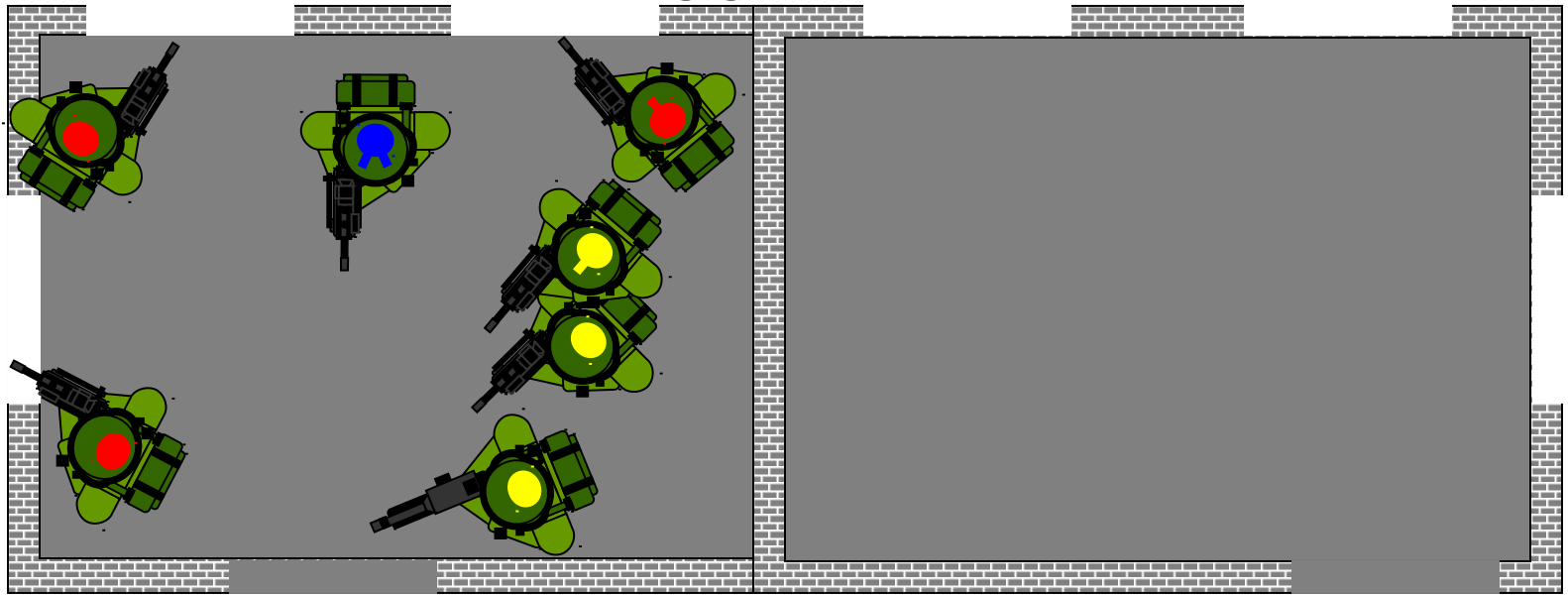

SORTIE

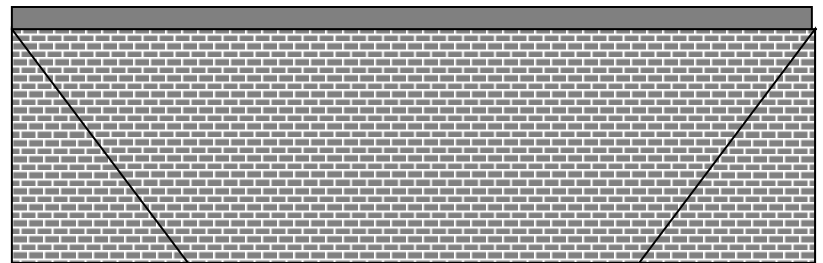
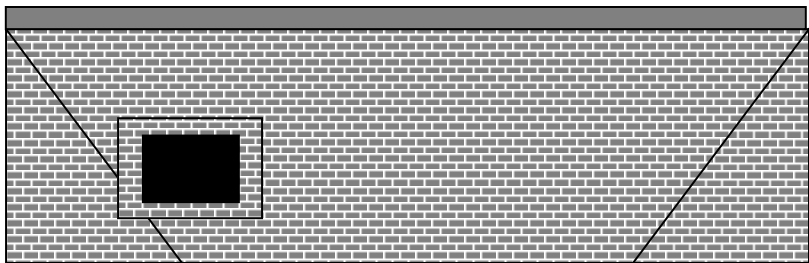
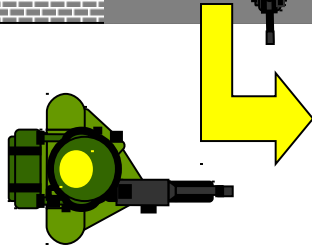
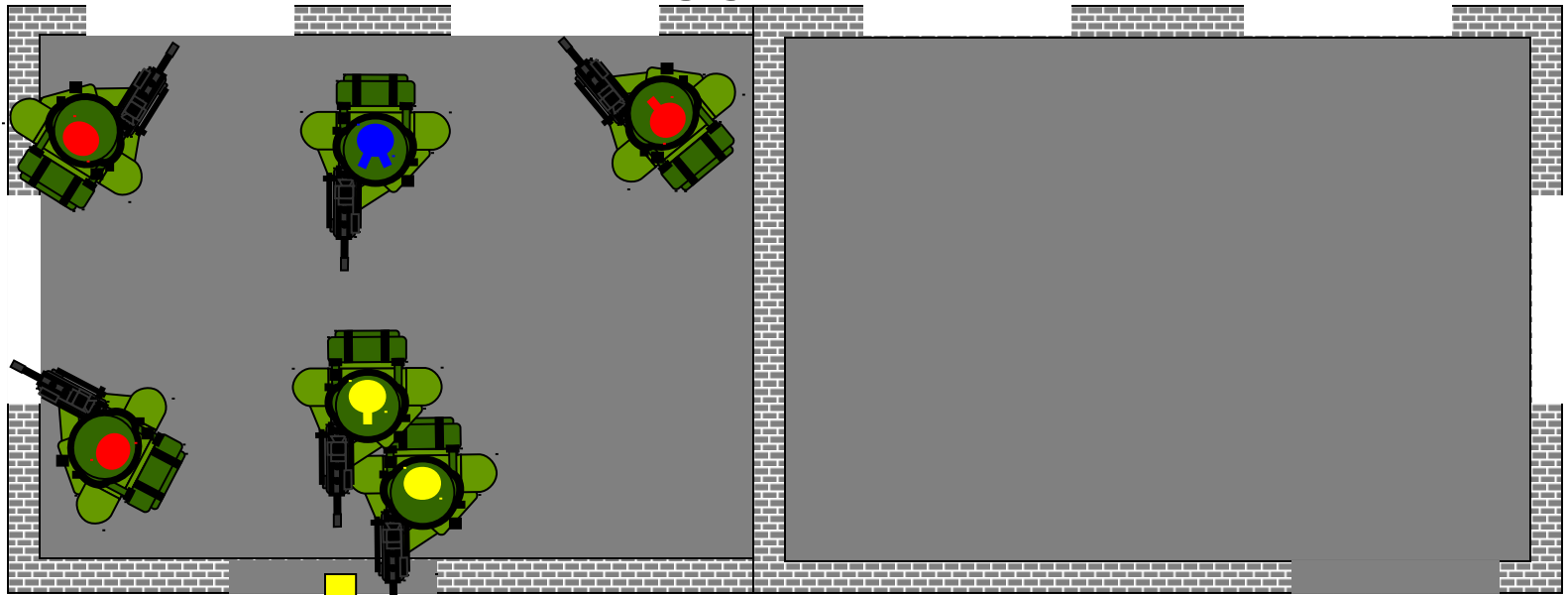

SORTIE

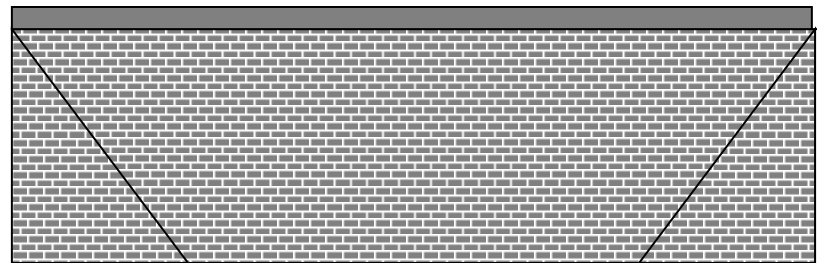
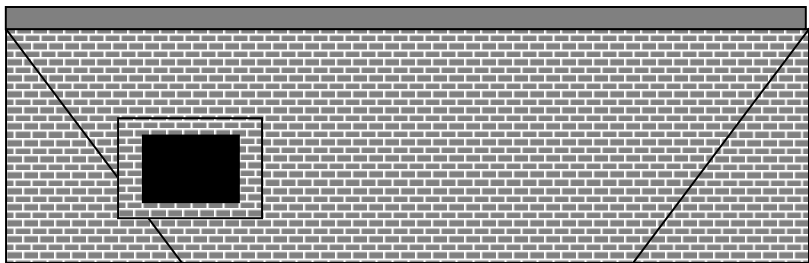
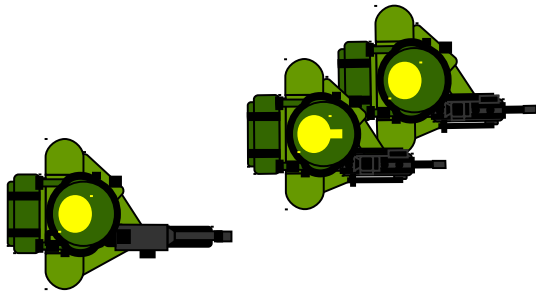
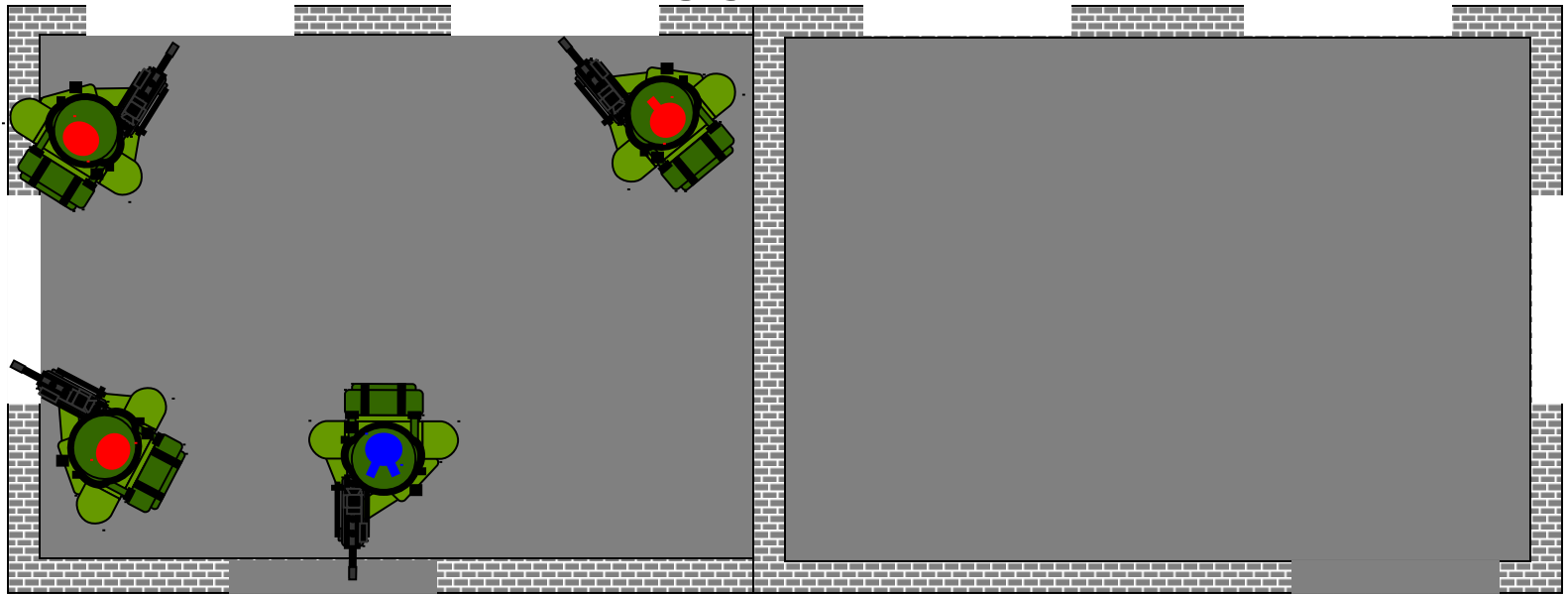

PROGRESSION

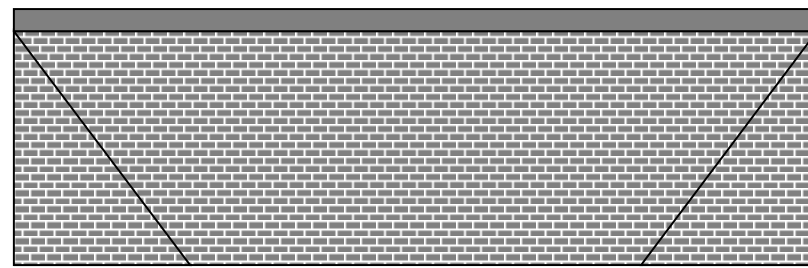
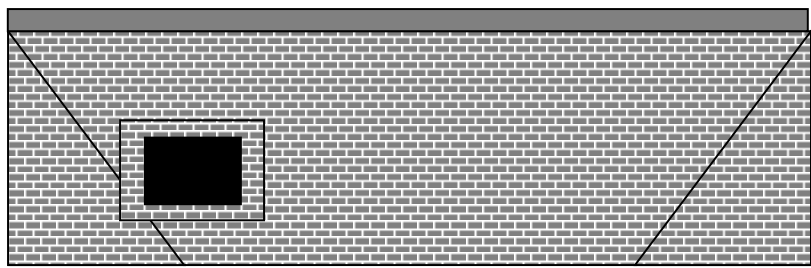
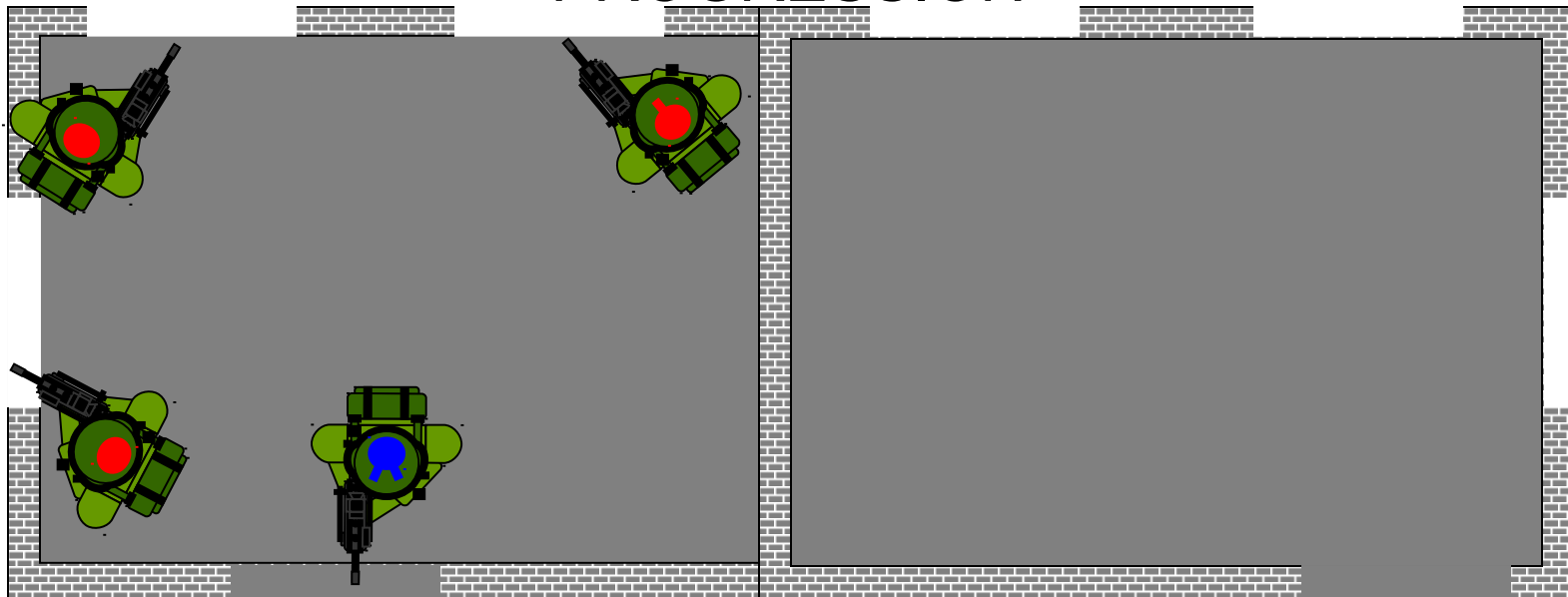

PROGRESSION

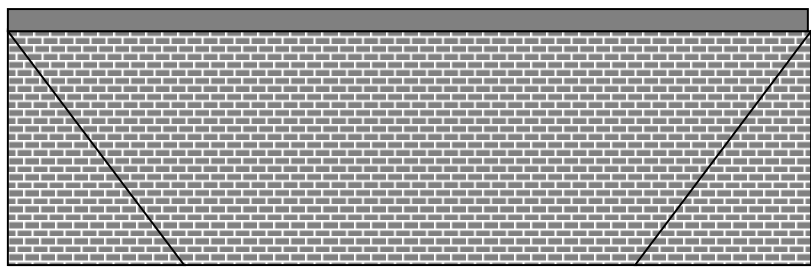
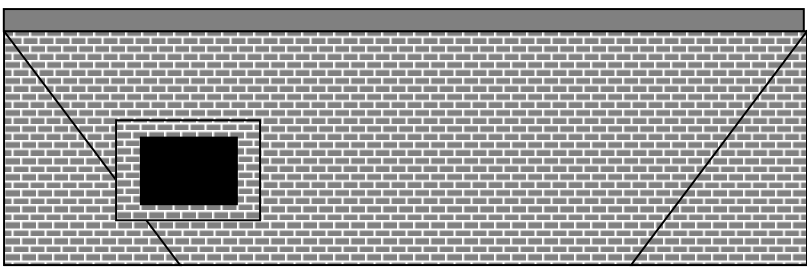
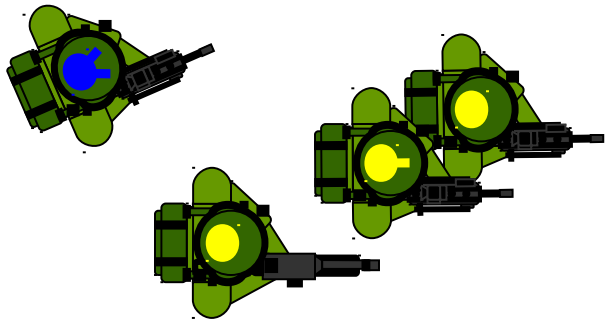
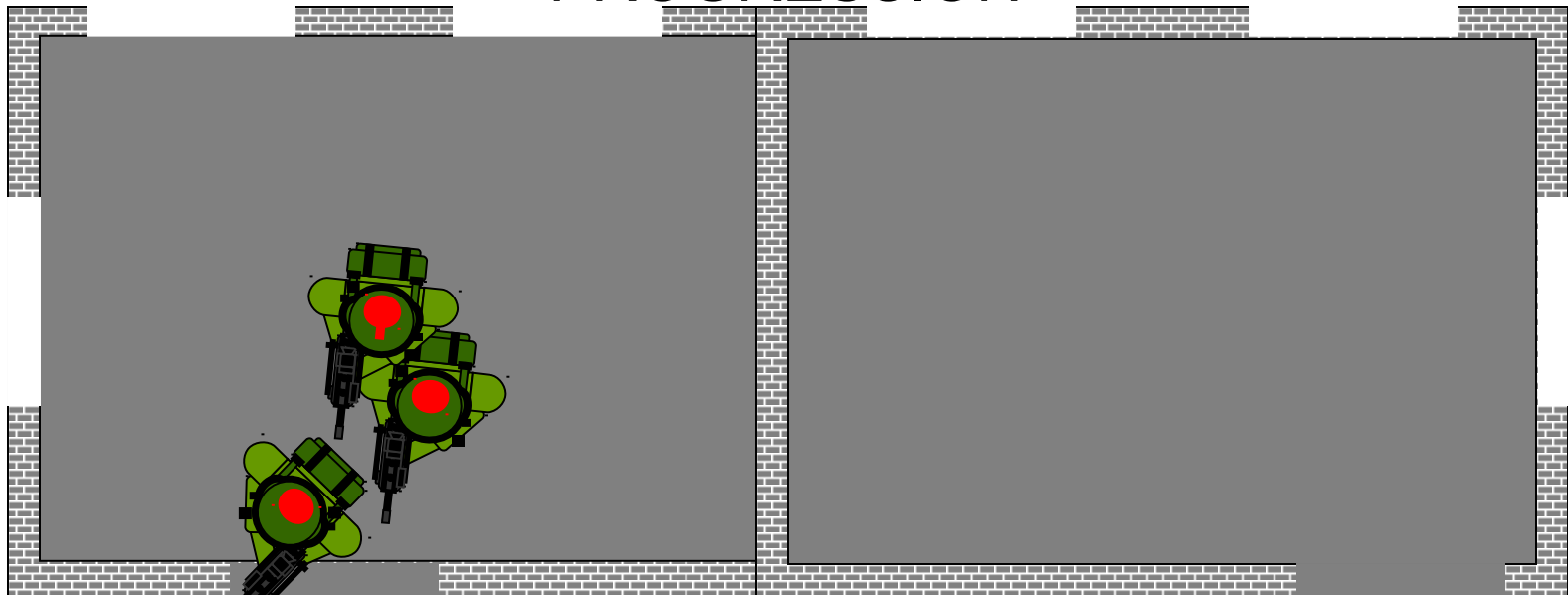

PROGRESSION

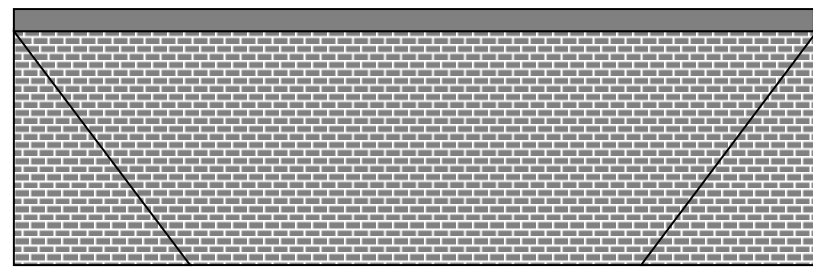
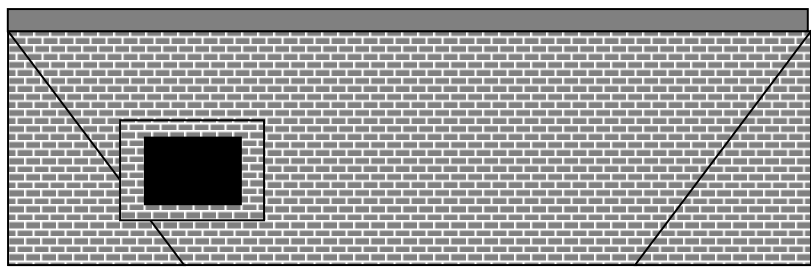
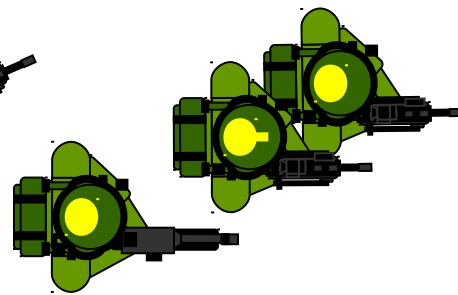
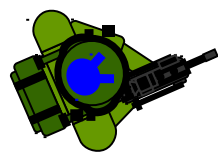
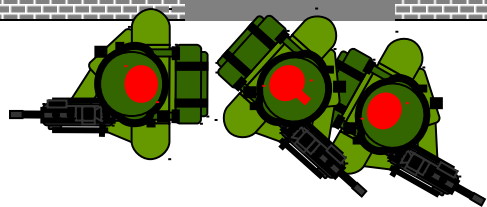
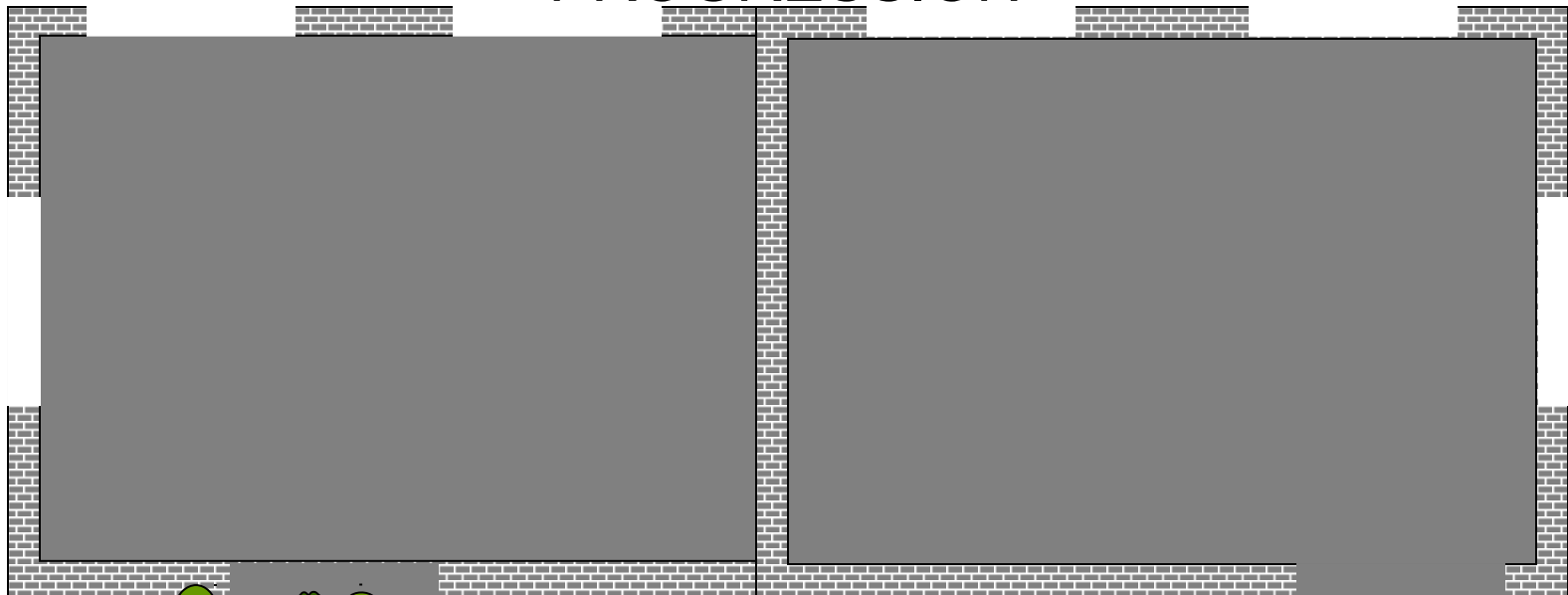

PRISE A PARTIE / ANNONCE / OUVERTURE DU FEU

BLESSE A AVANT
BLESSE A AVANT

BLESSE A AVANT
BLESSE A AVANT

BLESSE A AVANT
BLESSE A AVANT

BLESSE A AVANT
BLESSE A AVANT

BLESSE A AVANT
BLESSE A AVANT

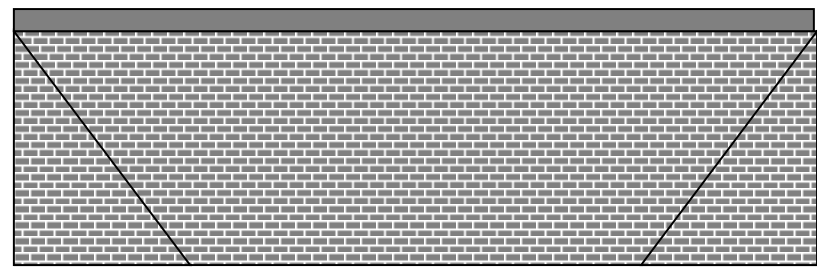
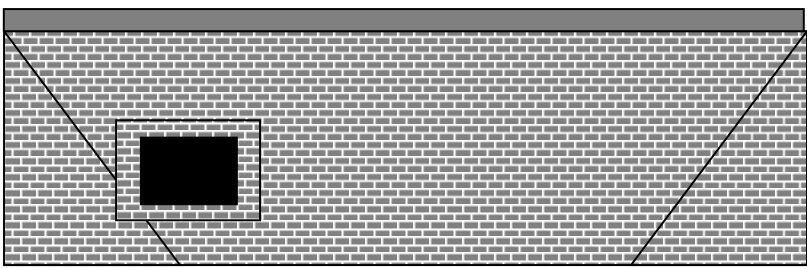

PRISE DE DECISION / REPERCUTION

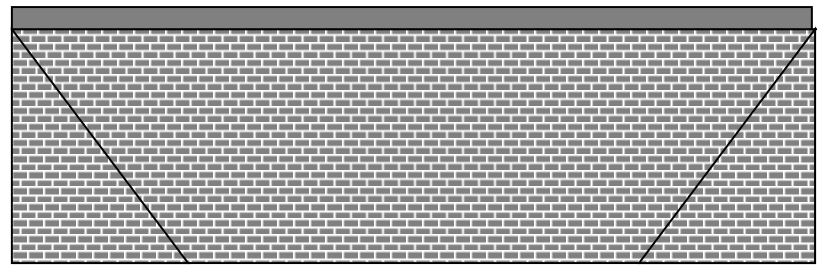
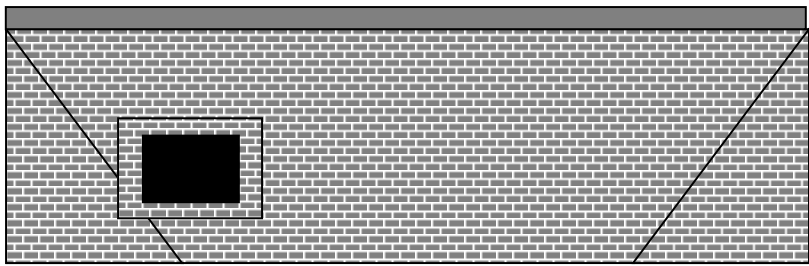
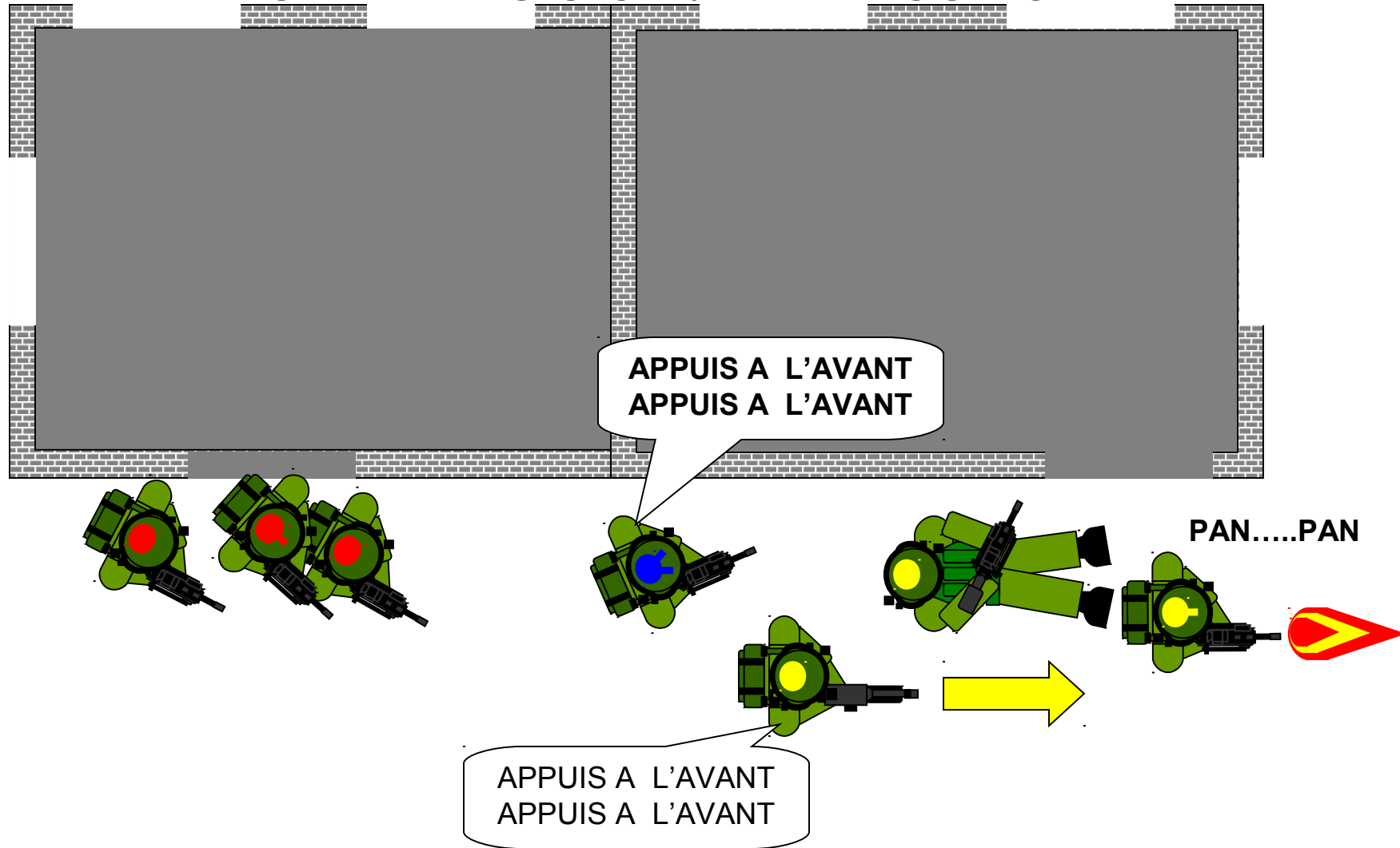

EXECUTION

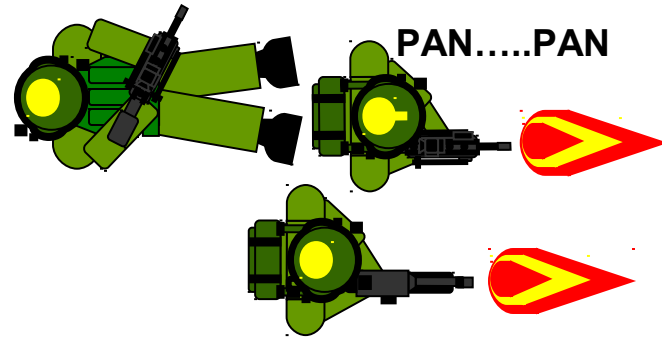
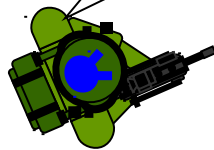
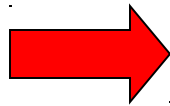
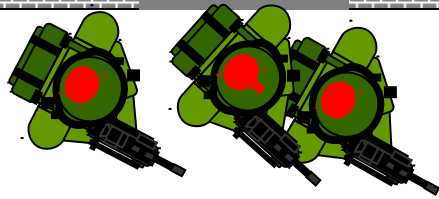
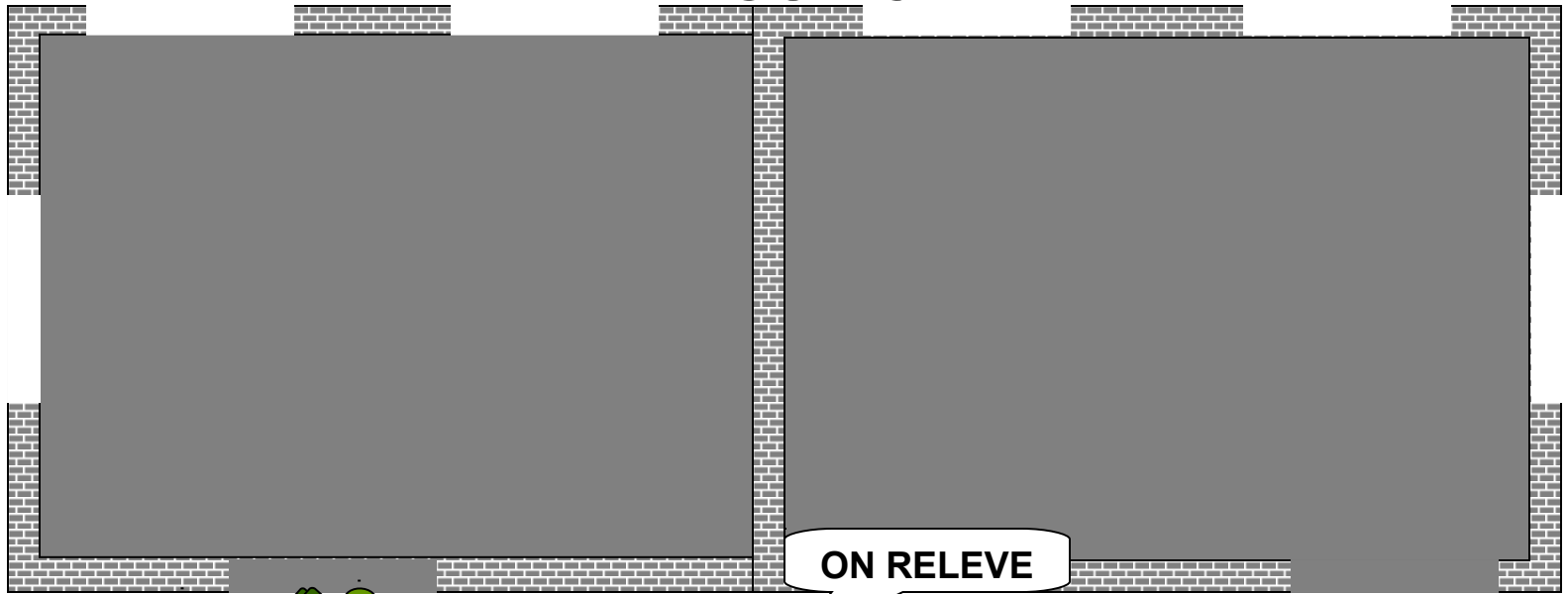

PAN....PAN

TAC A TAC

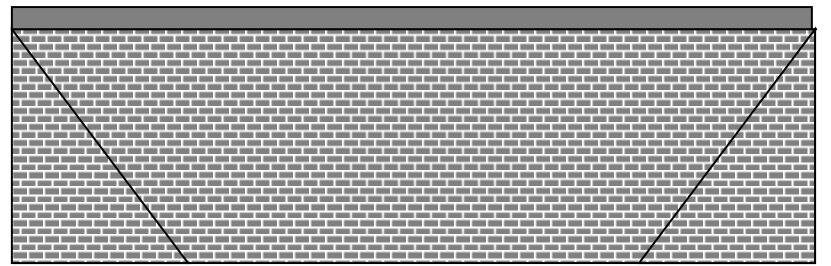
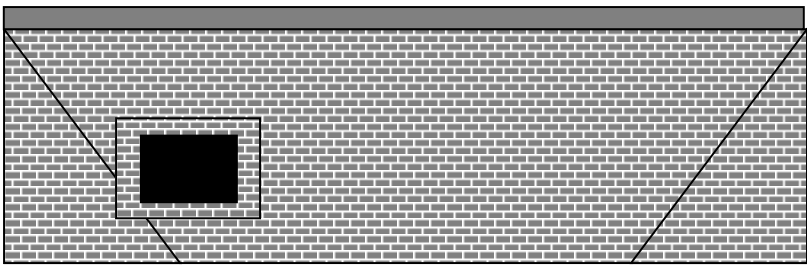

EXECUTION

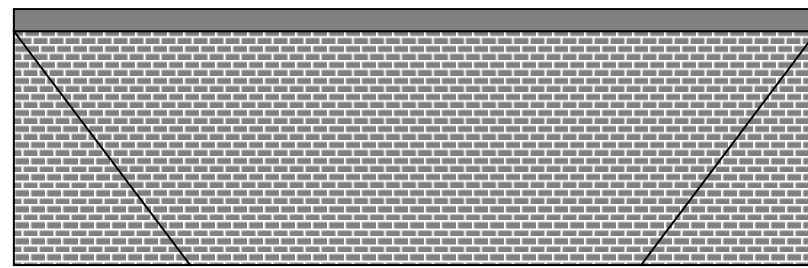
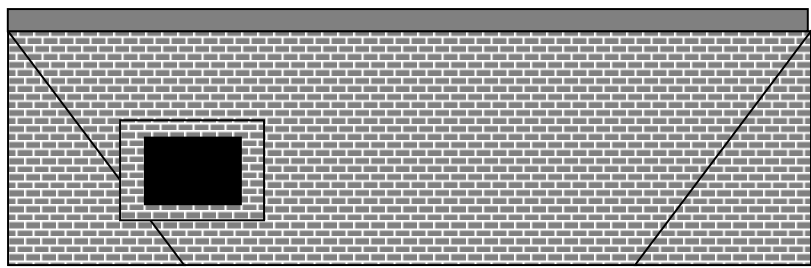
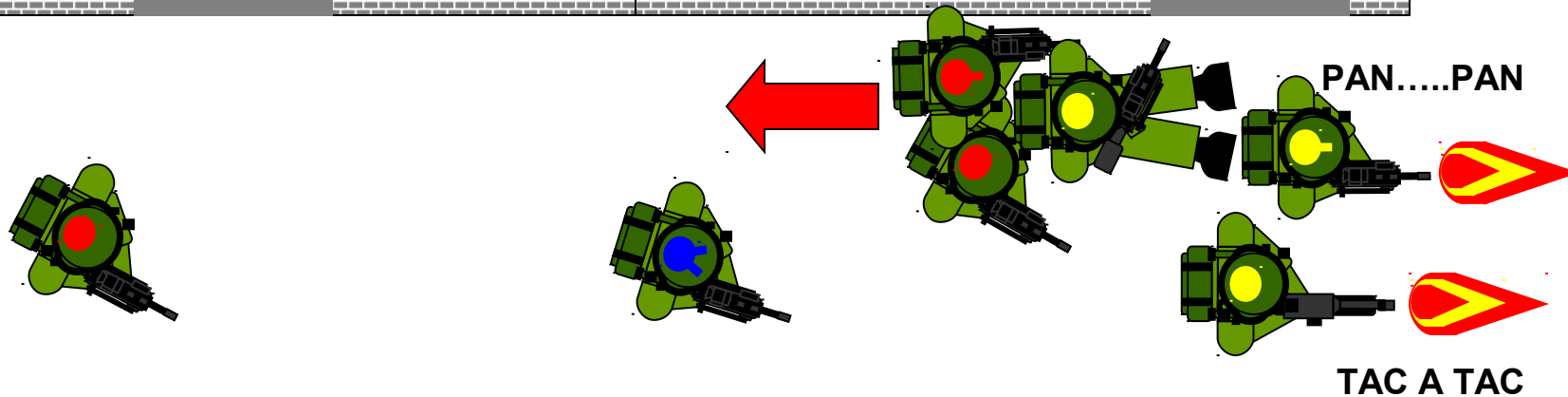
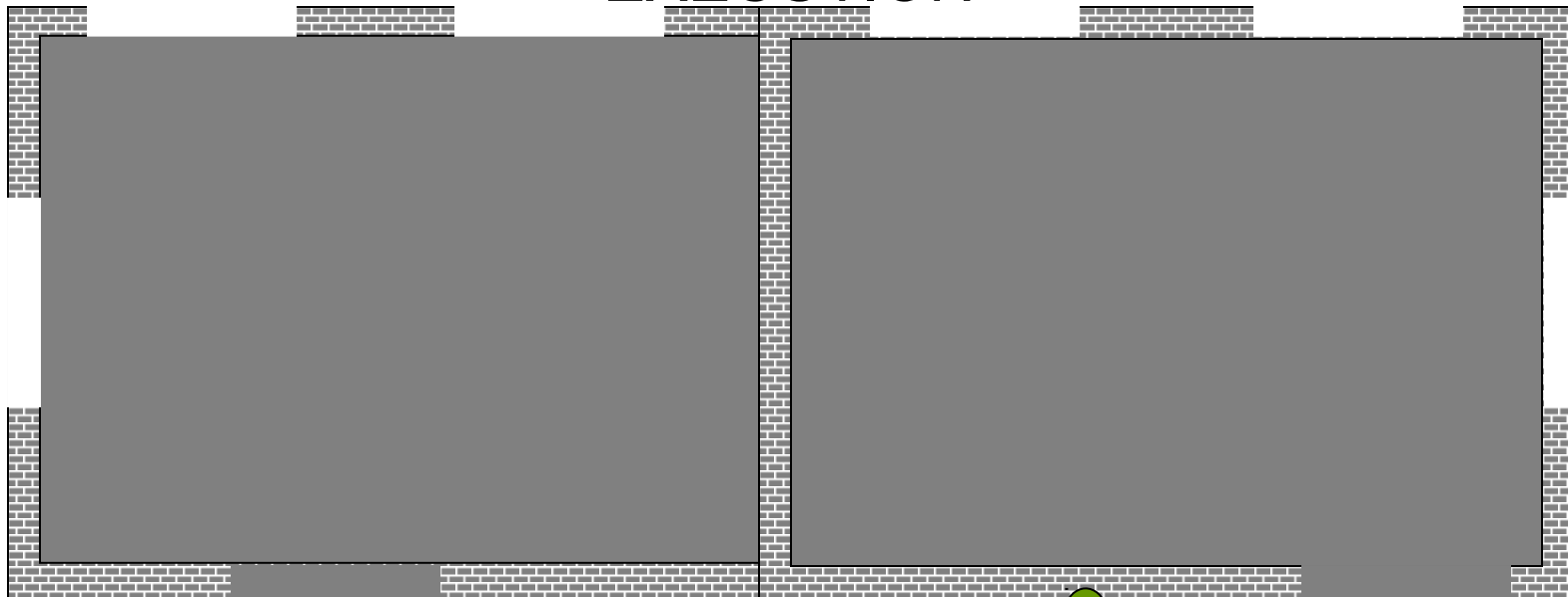

RUPTURE DE CONTACT

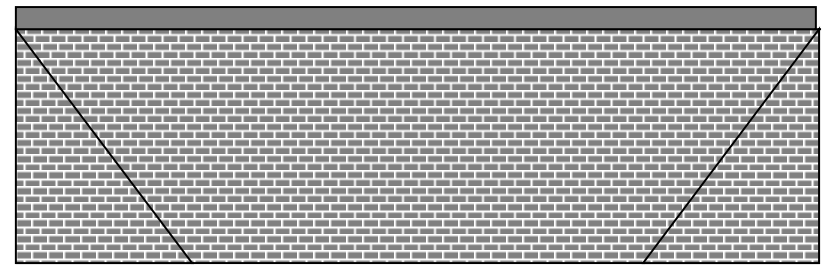
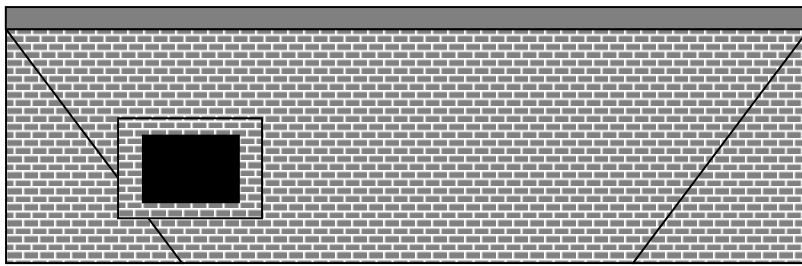
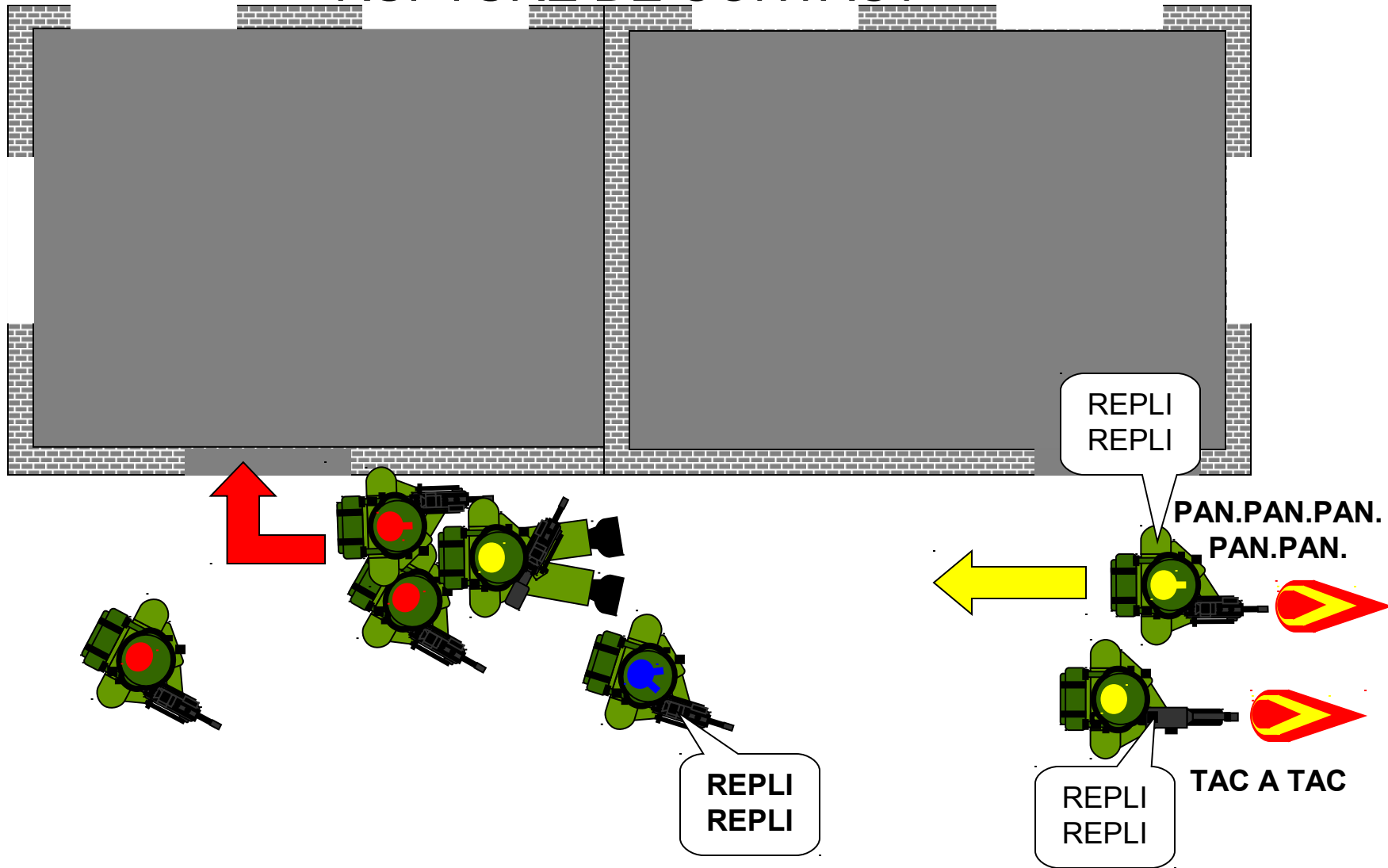

RUPTURE DE CONTACT

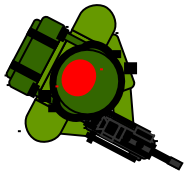
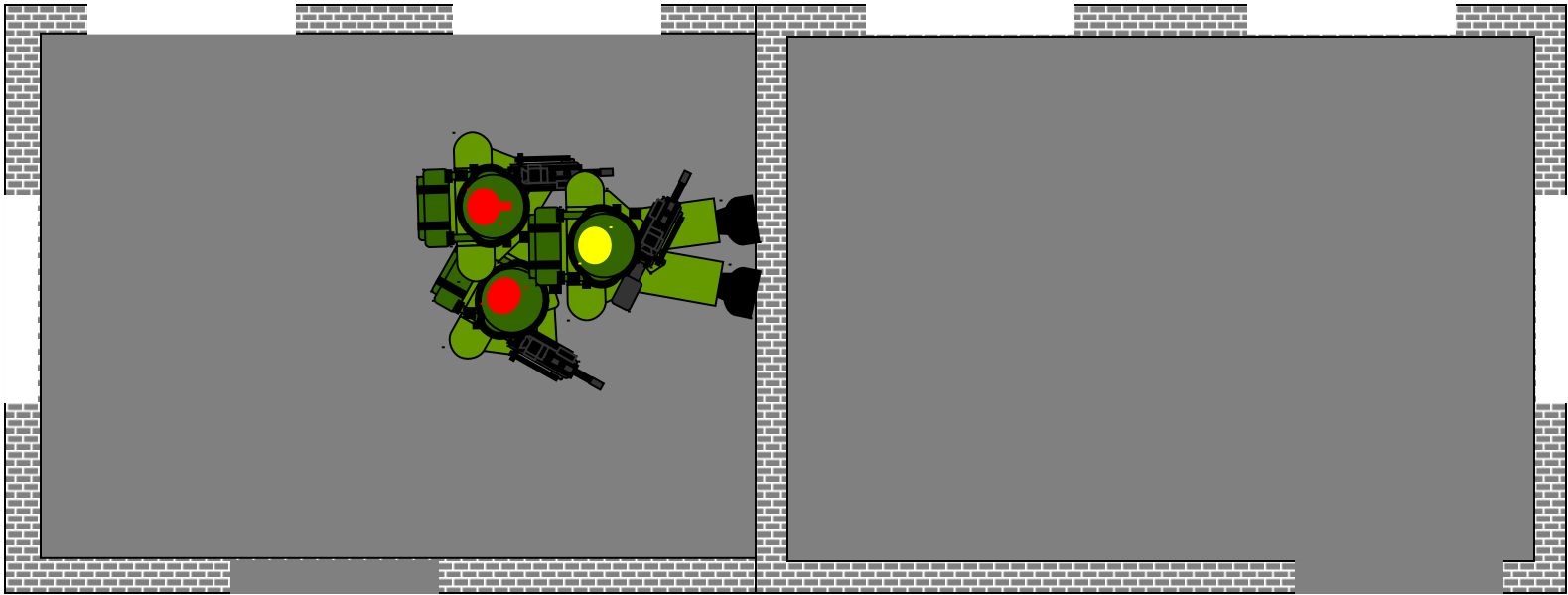

PAN....PAN

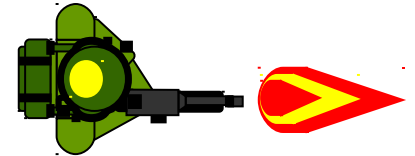
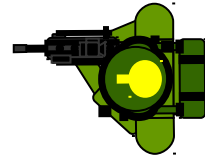

TAC A TAC
A TAC A TAC

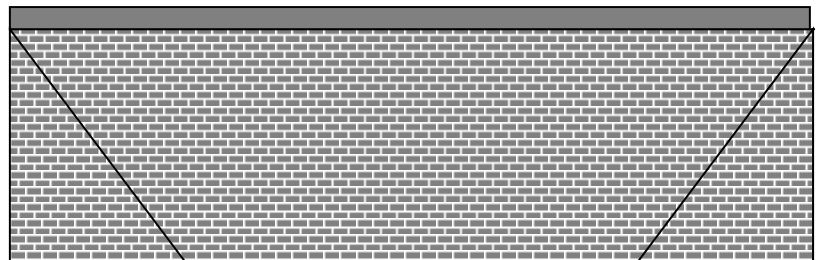
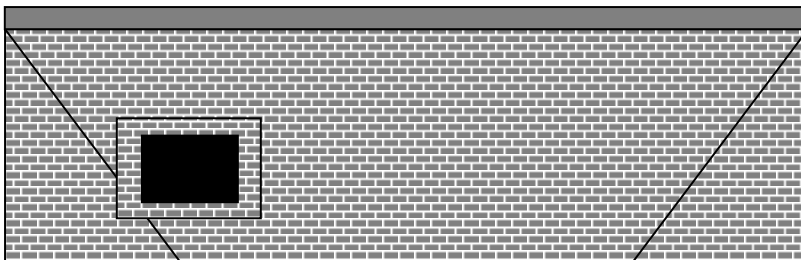

RUPTURE DE CONTACT

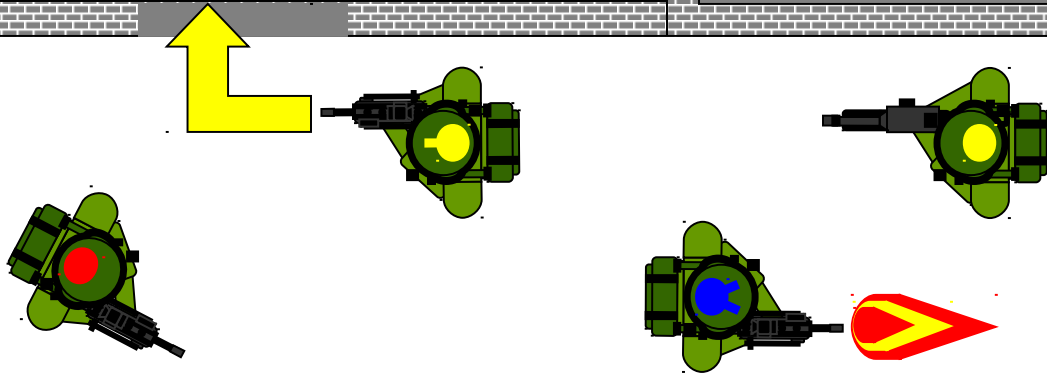
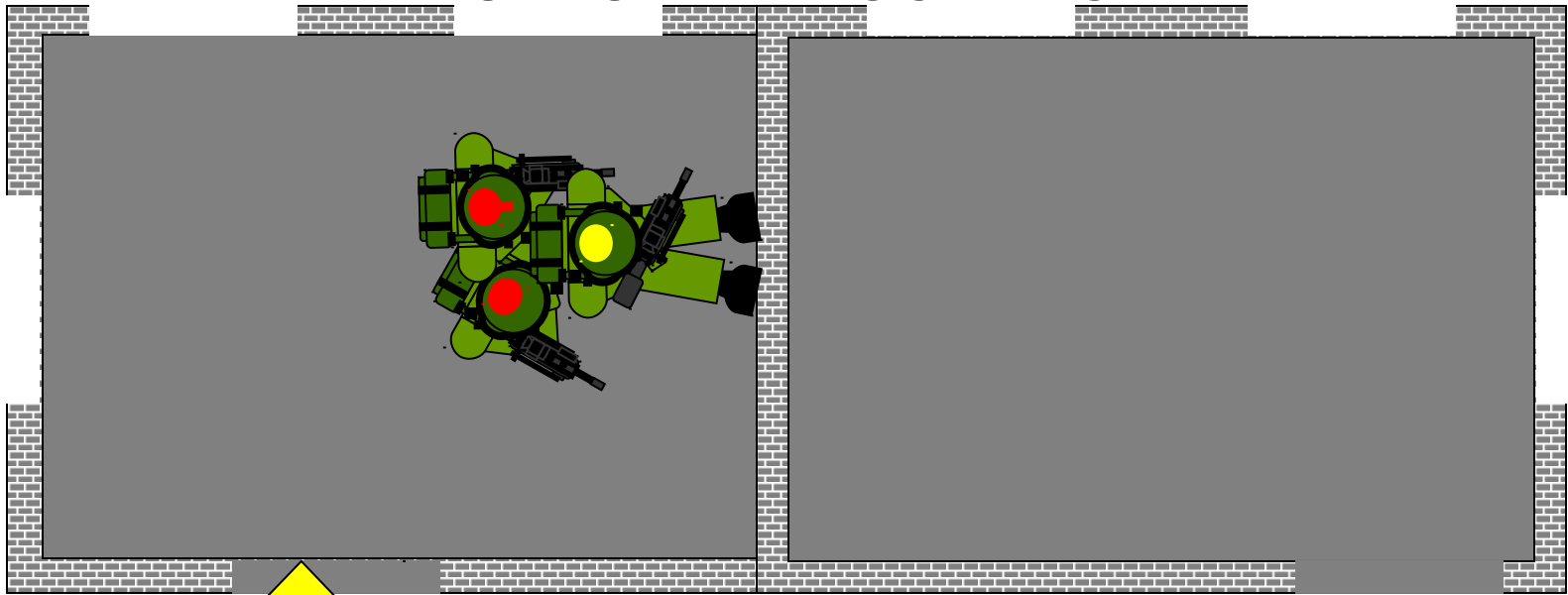

PAN.....PAN

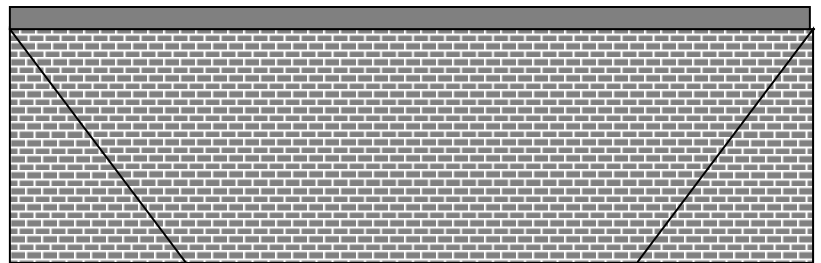
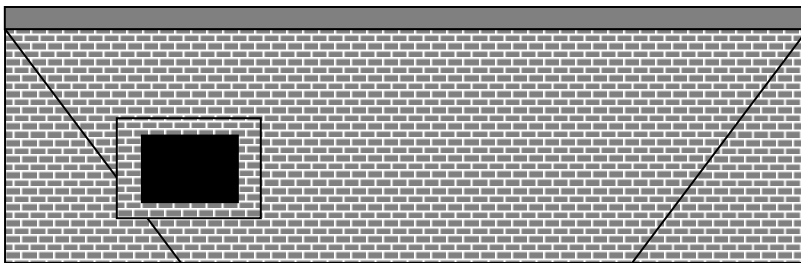

RUPTURE DE CONTACT

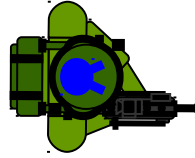
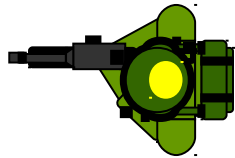
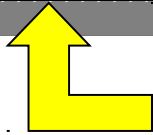
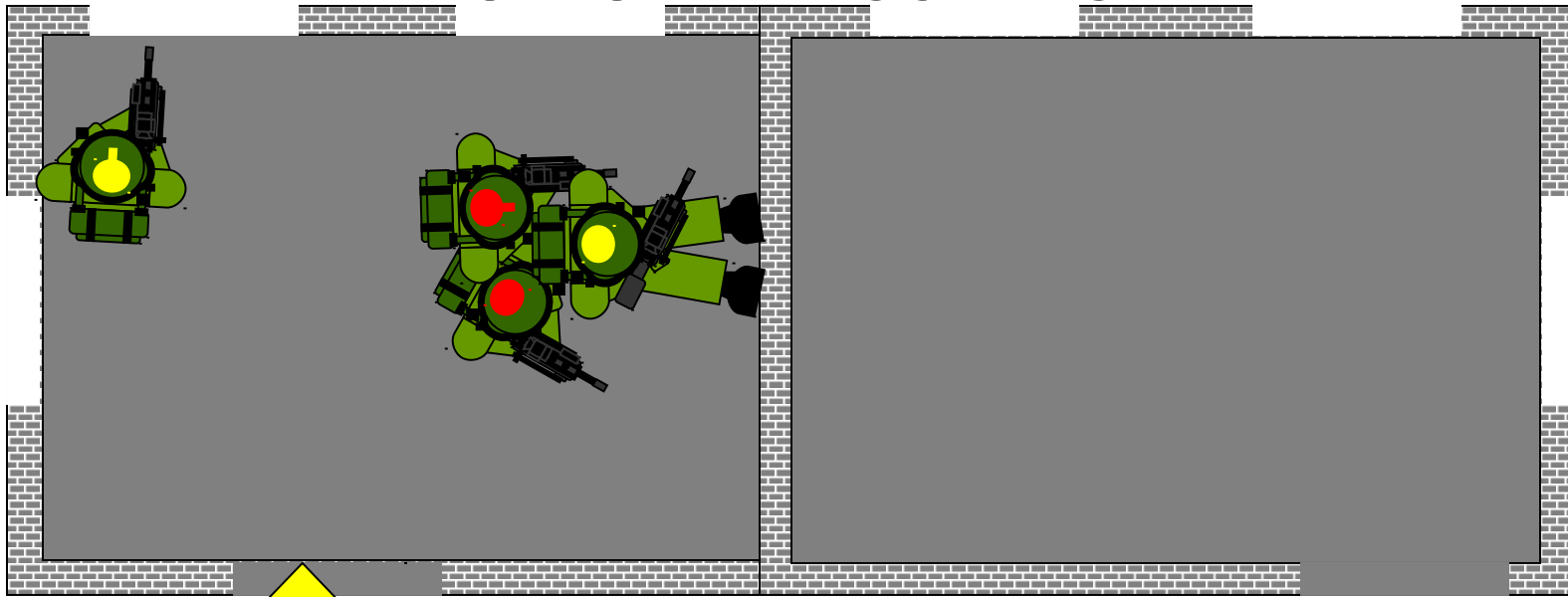

PAN.PAN.PAN.
PAN.PAN.



PAN....PAN

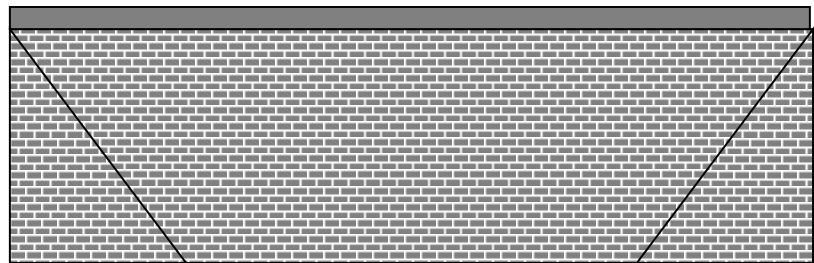
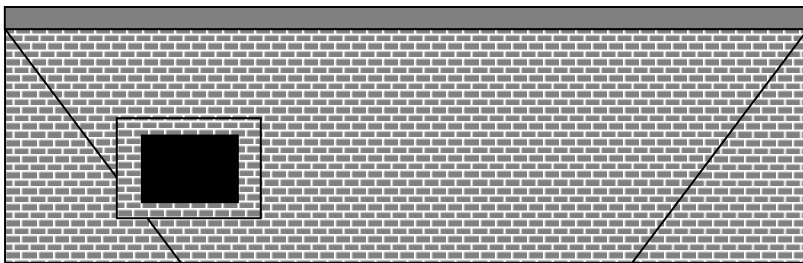

RUPTURE DE CONTACT

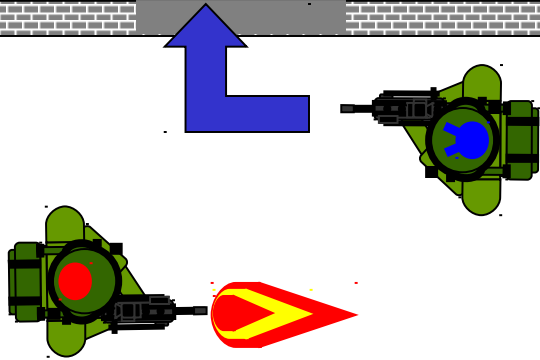
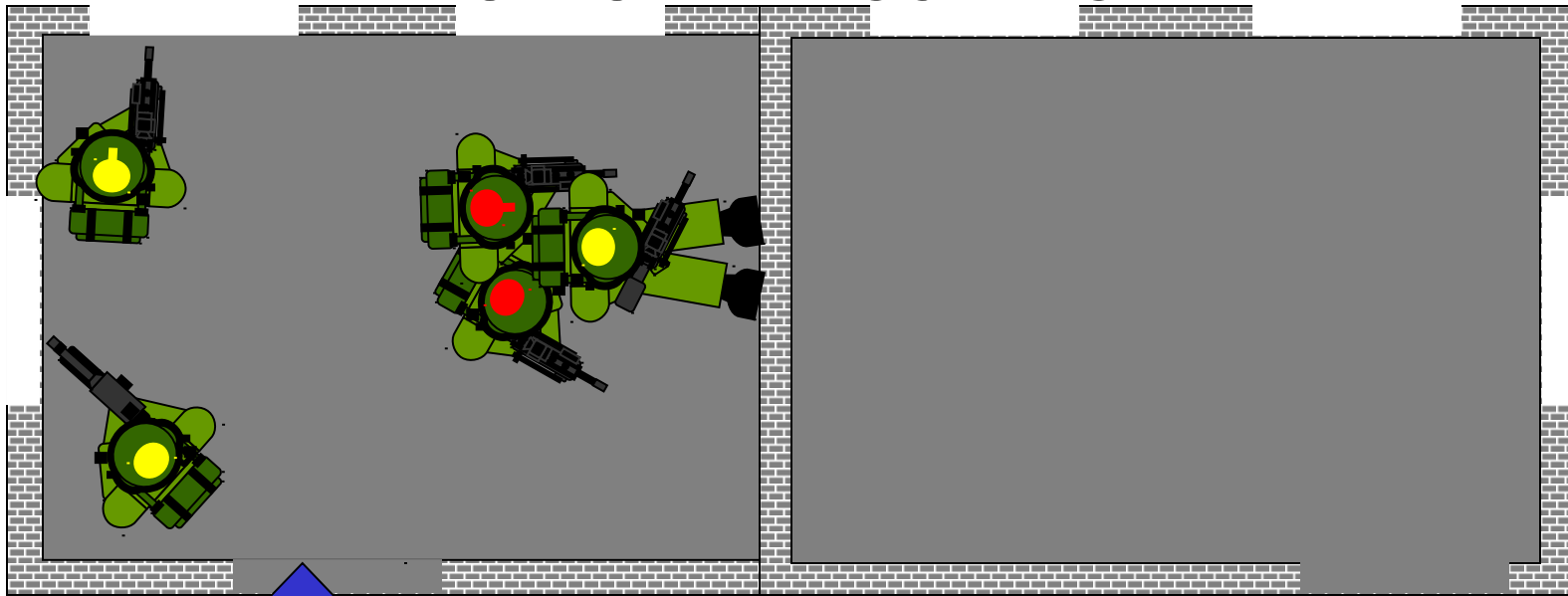

PAN....PAN

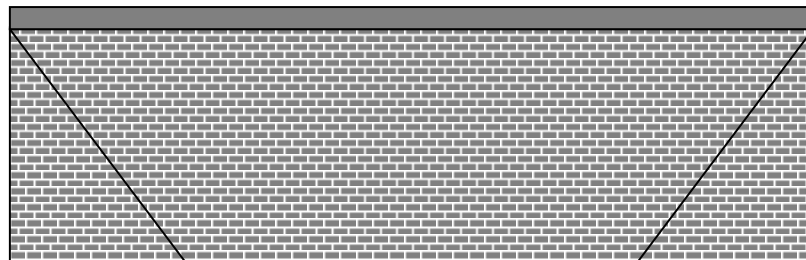
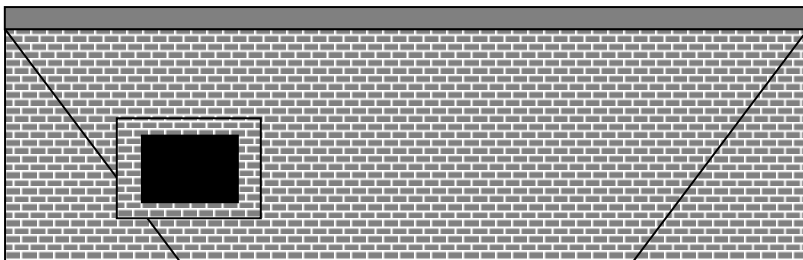

RUPTURE DE CONTACT

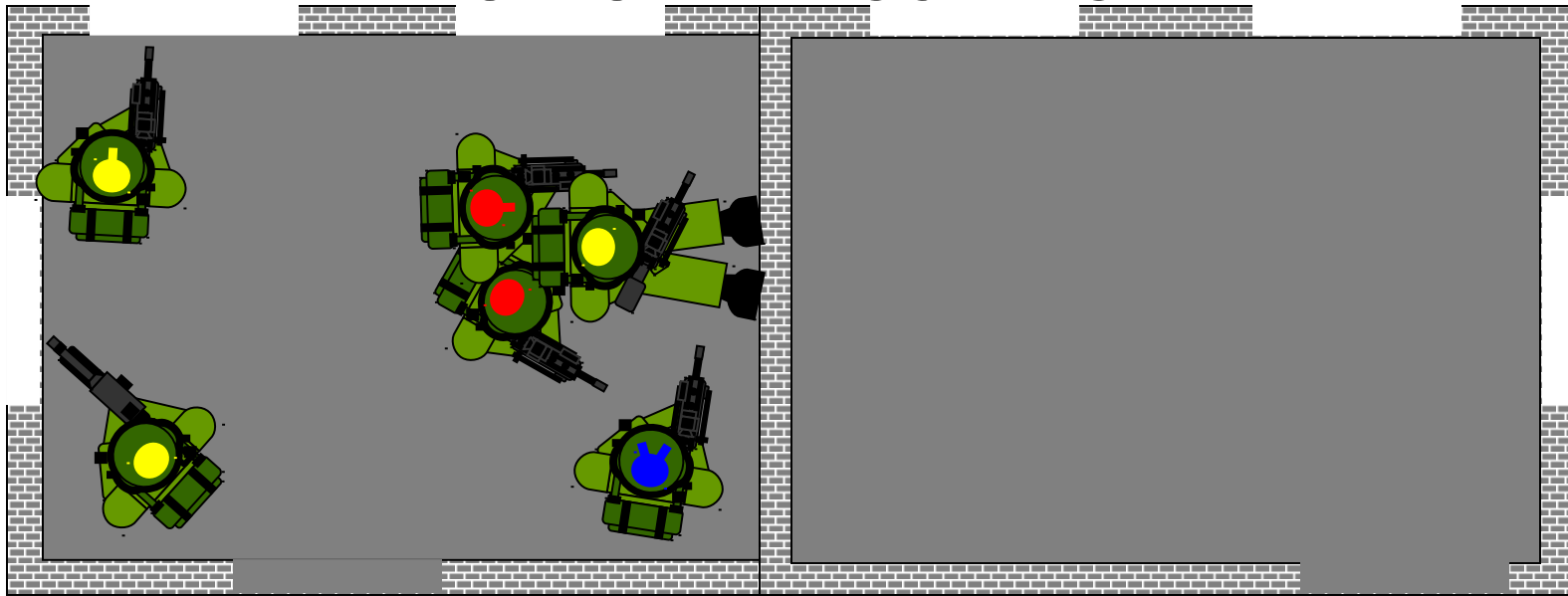

PAN.PAN.PAN.
PAN.PAN.

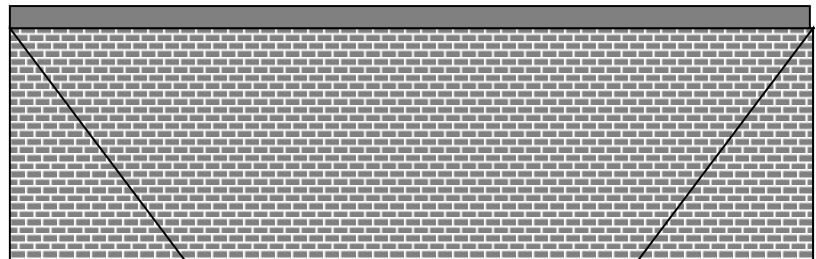
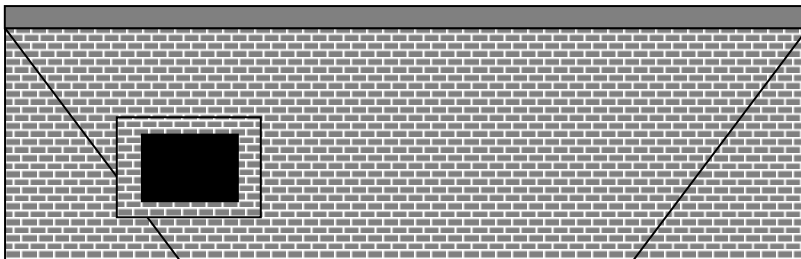

RUPTURE DE CONTACT

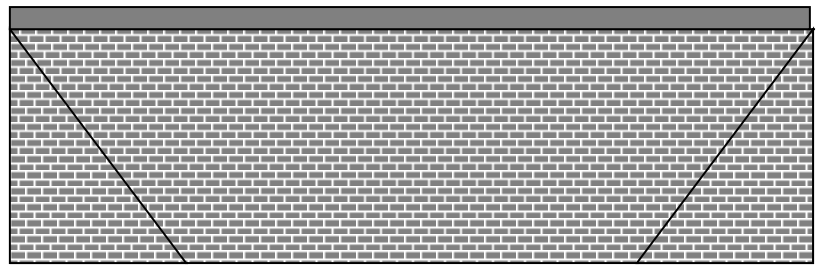
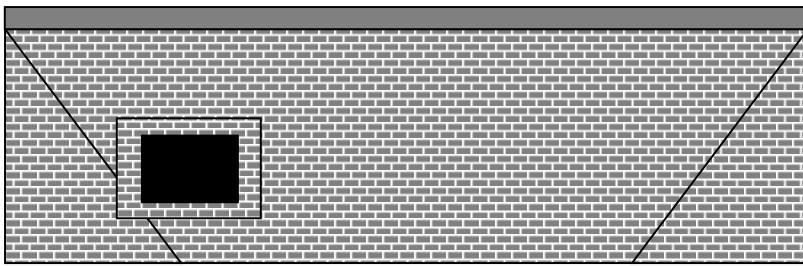
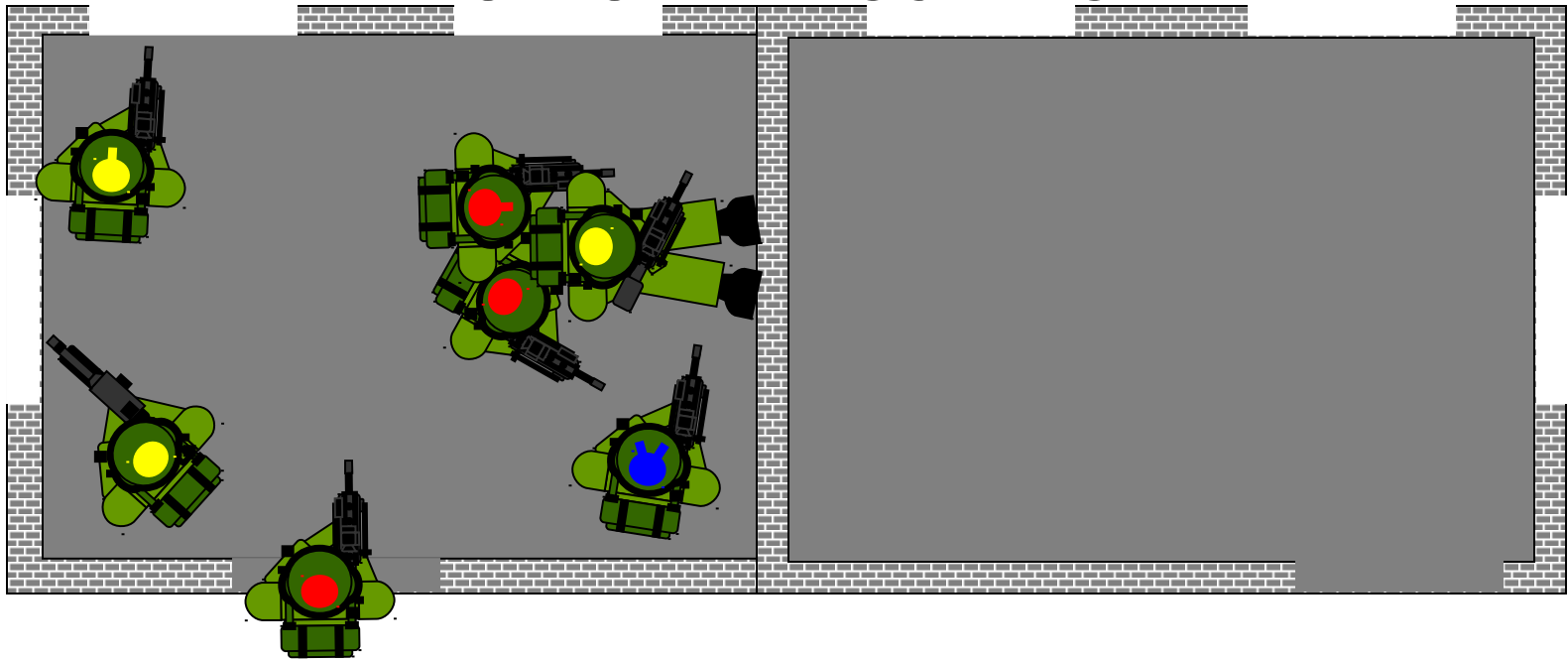

CONDITIONNEMENT DU BLESSE / CONTRÔLE PERSONNELS

